

ASSEMBLY INSTRUCTIONS FOR



less work, more game



KEMET®

QUICK >> START INSERT™

Kemet ® is a registered trademark of Lautapelit. Any mention of Kemet ® is for reference purposes only. ALL RIGHTS RESERVED by their respective trademark holders. No challenge to any intellectual property rights is intended or implied by representations of compatibility and no endorsements of any of our products by any other company is implied or represented.



**QUICK»START INSERT™ FOR
KEMET®**

General Assembly Instructions

The following are basic instructions for any of the Quick Start Inserts:

- All panels are labeled with an Alphabet letter (A, B, C, etc.). First sort all panels into piles by their letters before you begin to assemble.
- Layout the parts in the diagrams provided, to ensure you have all the parts
- Glue only the edges that come into contact with the wood (remove excess immediately)
- Allow 24 hours to dry before using

Tips & Tricks

- Some of the parts might need to be slightly sanded on the edges for a perfect fit.
- Sometimes tapping the pieces with a small amount of force (with a mallet) helps create a tighter fit.
- Taping the outside corners of the boxes helps it hold in place while the glue is drying.
- If you break a part, don't hesitate calling we always carry spares – you just need to cover shipping. (most spares can be send in an envelope, if so we don't charge for shipping)

Assembly Supplies



Beacon 527 or wood-glue
(we recommend supper-glue)

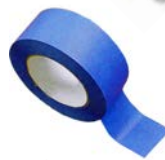

Painters blue tape
(painter's tape helps protect the finish)



Rubber mallet
(or something to tap the pieces together)



Cotton swap/ Q-tip
(or something to wipe the excess glue)



QUICK START INSERT™ FOR KEMET®

A B C D

O

N
J



G

H

I

L

K

F

E

This Quick Start Insert is compatible with Kemetic and its expansions. This is a non-licensed product. ALL RIGHTS RESERVED by their respective trademark holders. No challenge to any intellectual property rights is intended or implied by representations of compatibility and no endorsements of any of our products by any other company is implied or represented.



&



Sheet A1:

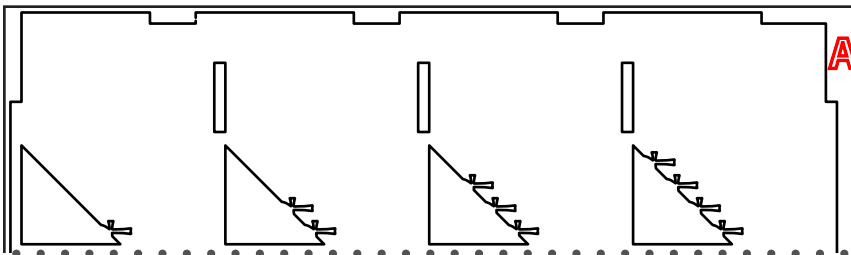

Sheet A2:

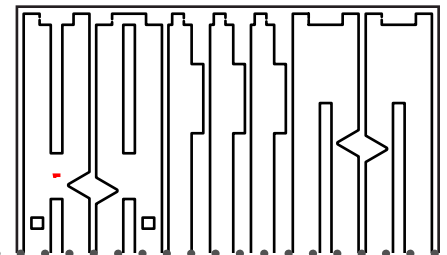

**PAY VERY CLOSE ATTENTION TO THE ASSEMBLY OF
THESE THREE TRAYS**

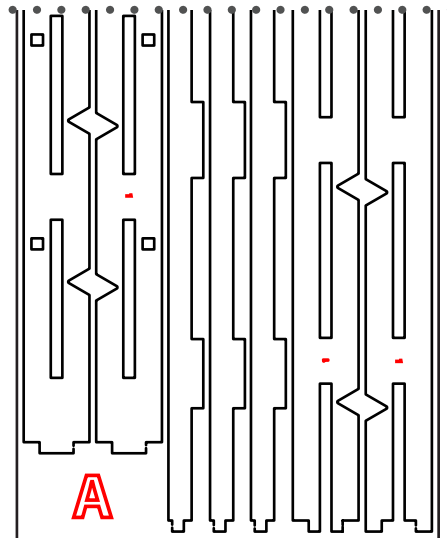
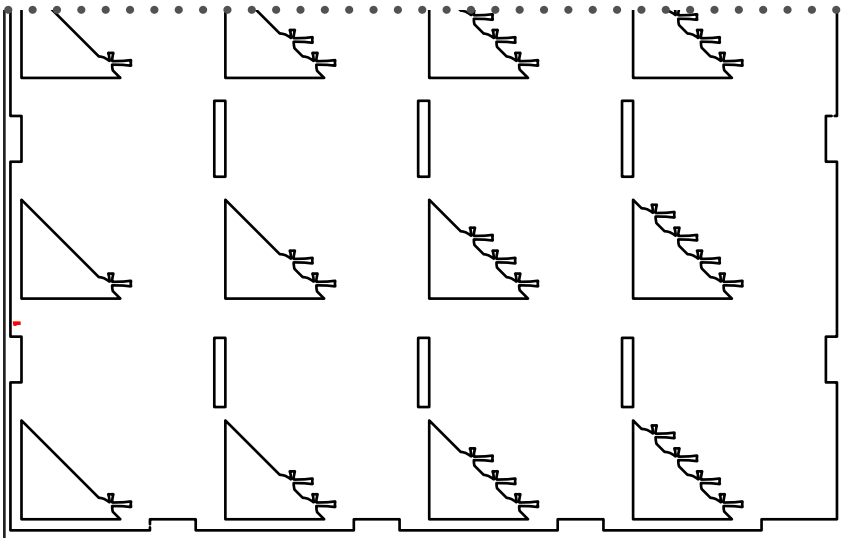



Sheet B1:

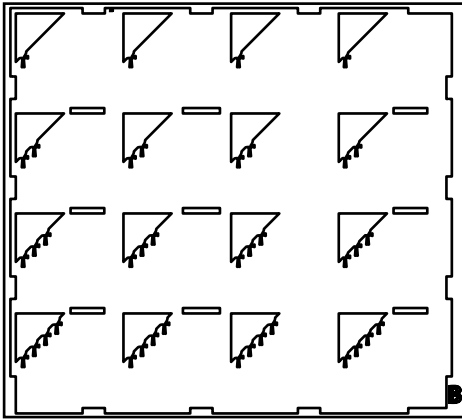

Sheet B2:

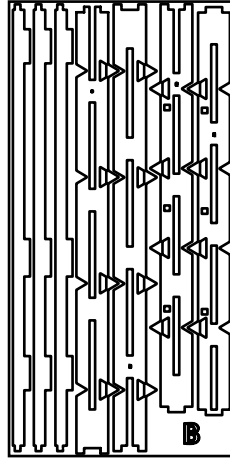

Sheet C1:

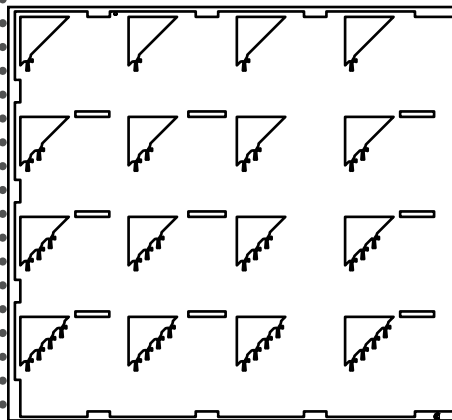

Sheet C2:

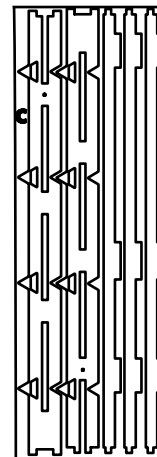

Sheet C3:

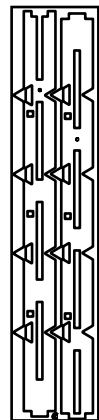

Sheet D1:

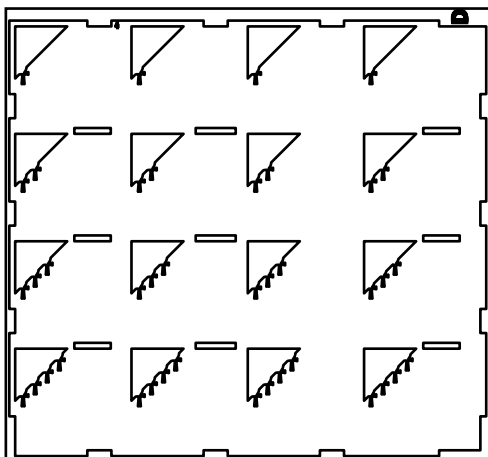

Sheet D2:

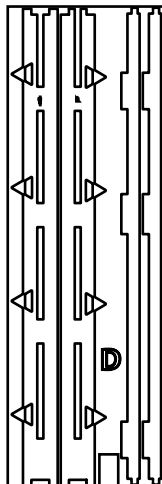



&



Step 1:

1. Glue and Assemble the 3 dividing tabs on all 4 trays (A, B, C, & D)

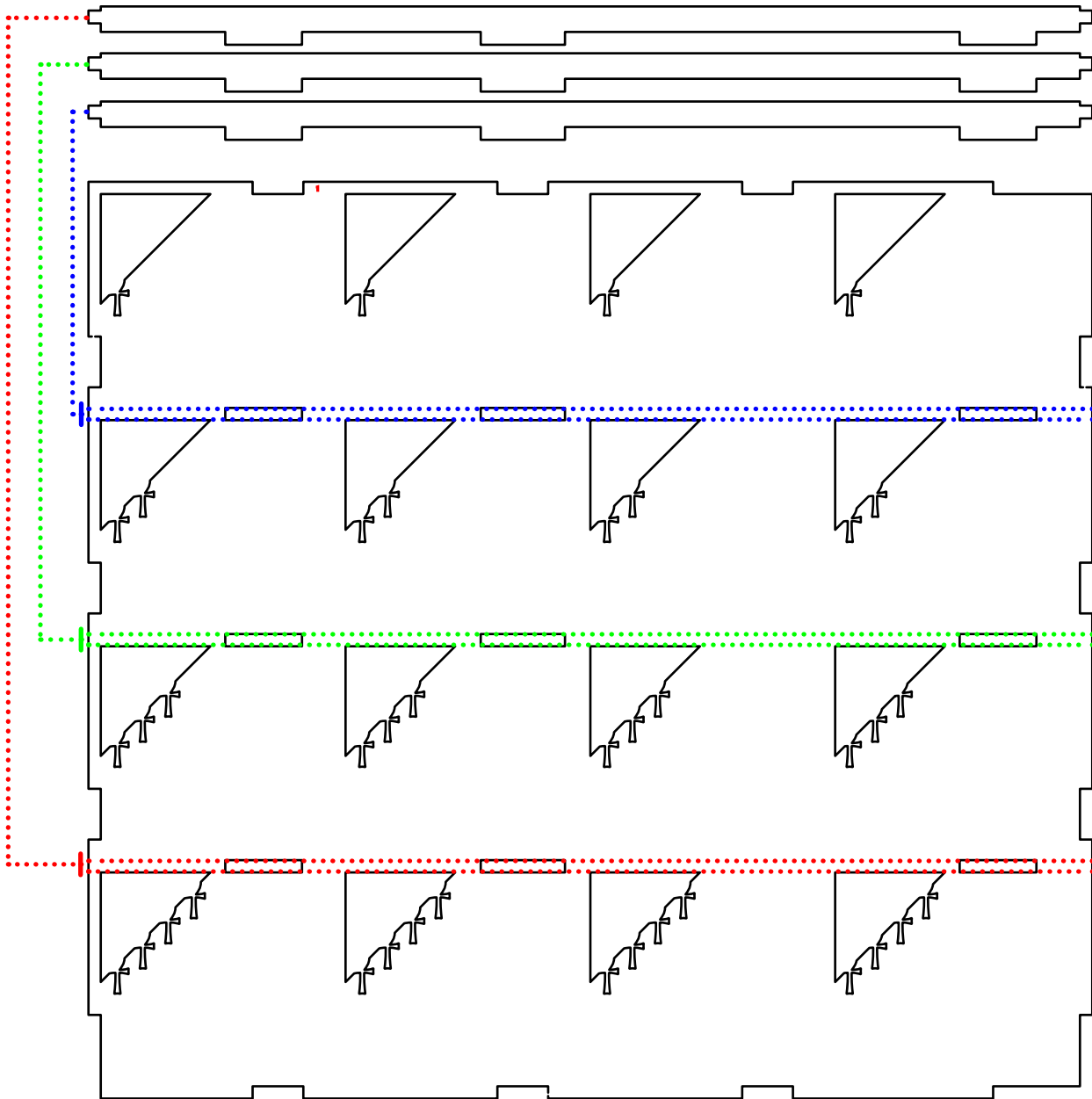



&



Step 2:

1. Layout all pieces like below

*Note: ~90% of edge pieces are unique

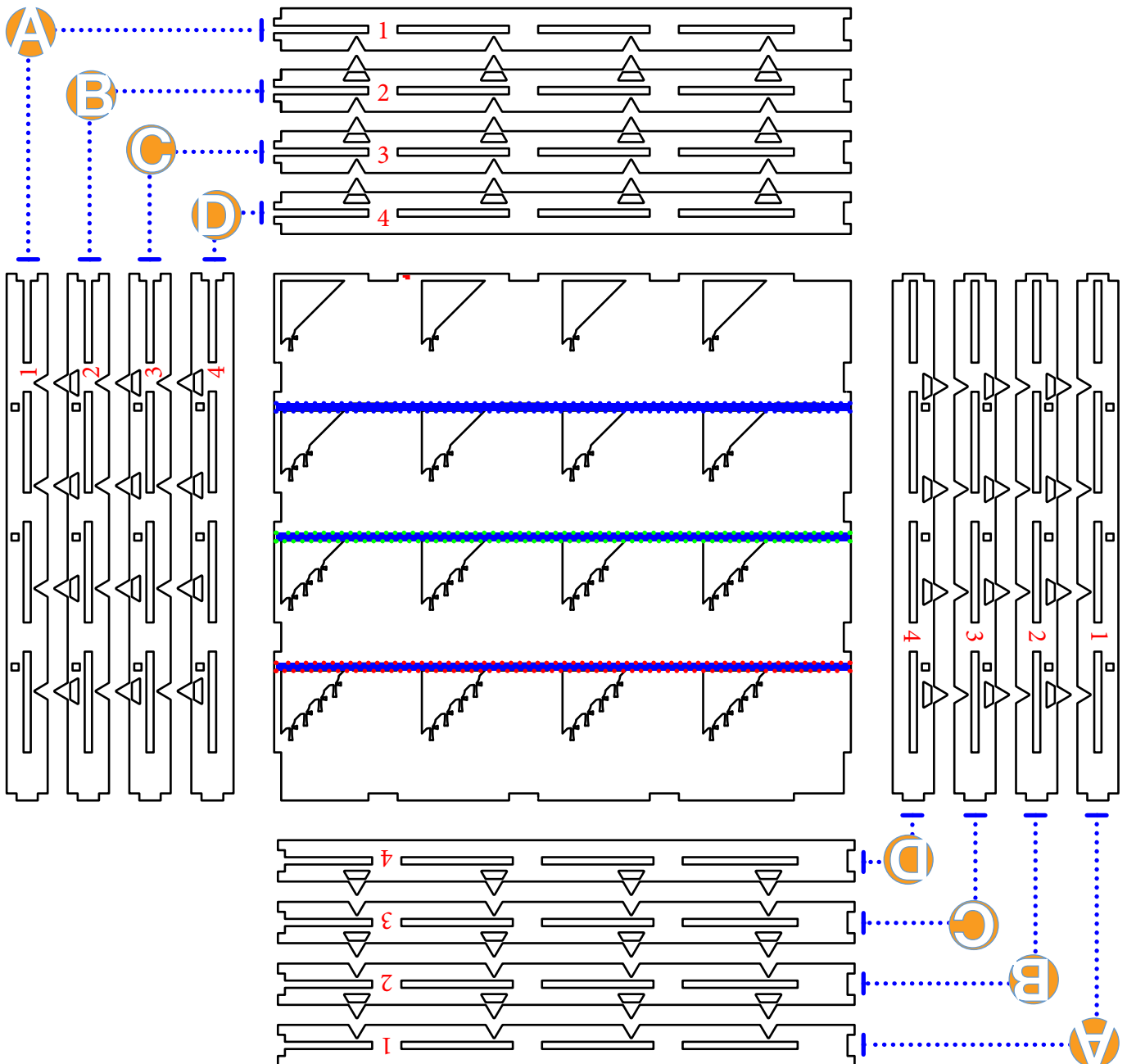



&



Step 3:

1. Being careful to keep each piece's orientation , Glue and Attach all **A** pieces to their center plate (Labeled with a #1)
2. Once you have Assembled and Tapped the corners on Tray A, set it upside down (smooth side down)
3. Repeat Step 3:1 for sections B, C & D pieces
4. Upon completion of Section B flit is upside down on Section A and tape together to glue. Repeat the same process for Sections C & D

**Note: Make sure you are careful to keep #1's flat side up, and the pyramid points up for #'s 2-4*

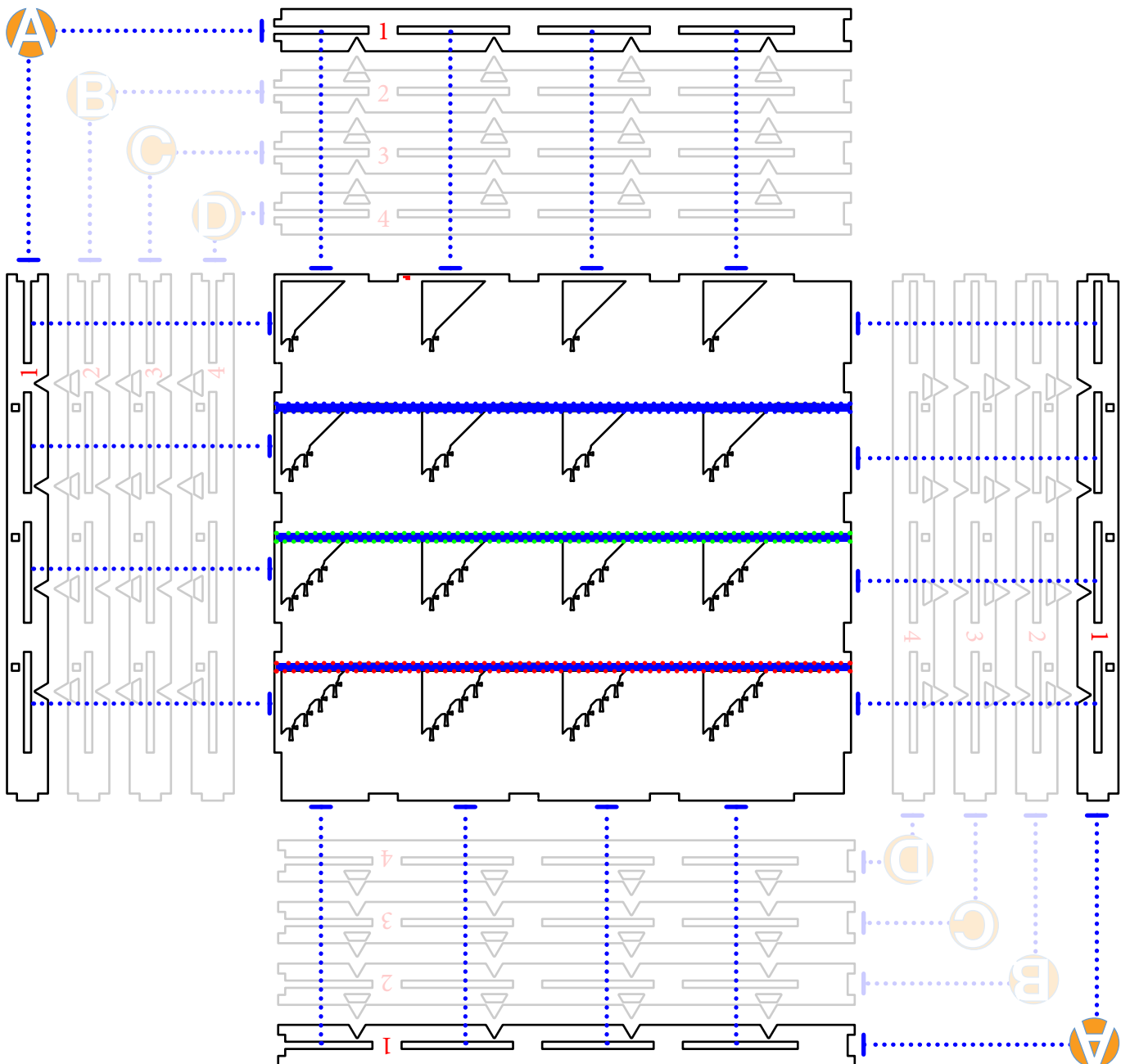



Sheet E1:

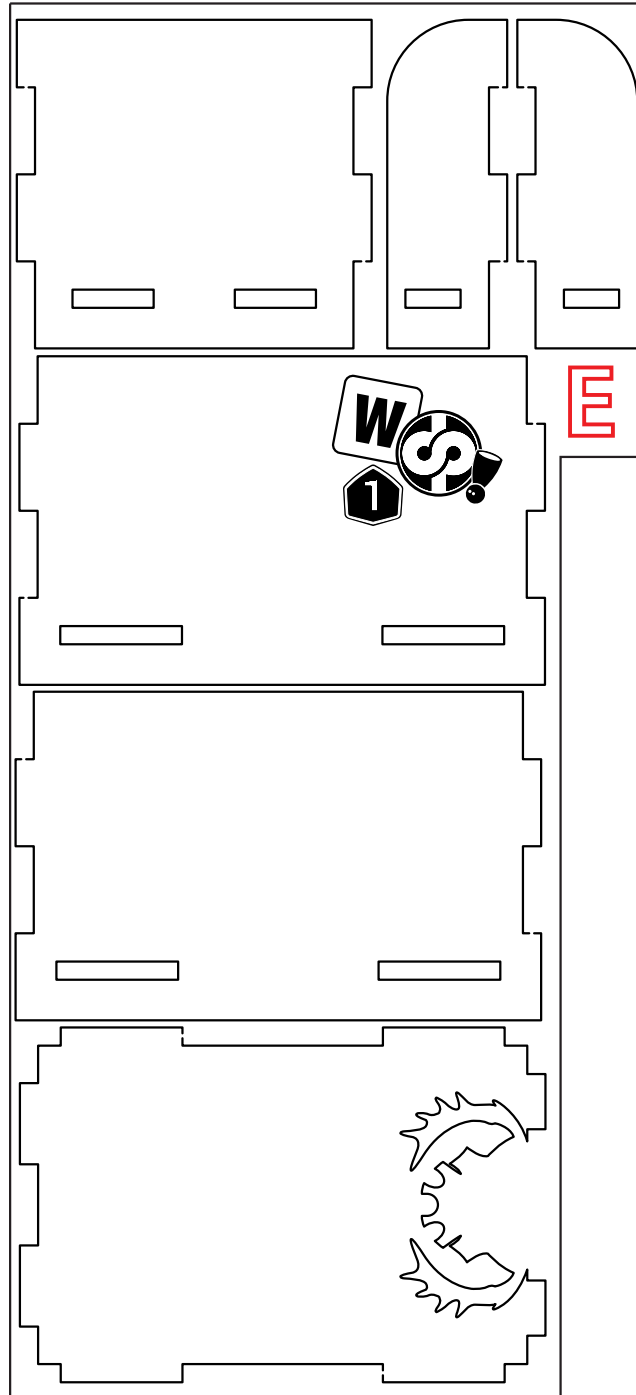



Recommended Assembly Sequence

1. Assemble middle pieces with dividers first
2. Glue and attach side 'wall' pieces
3. Glue and attach end pieces
- 4.

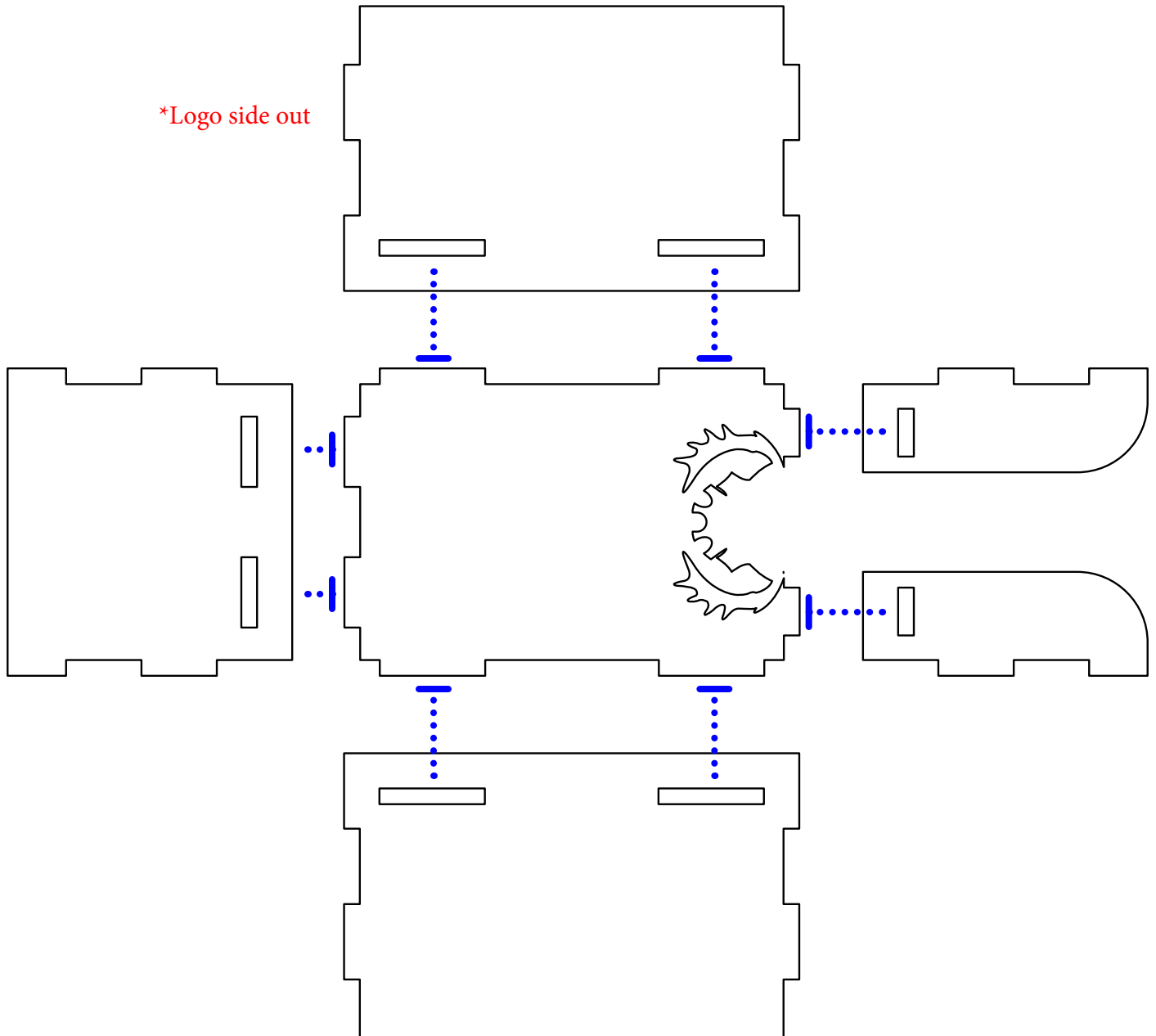



Glue Locations:

*Logo side out

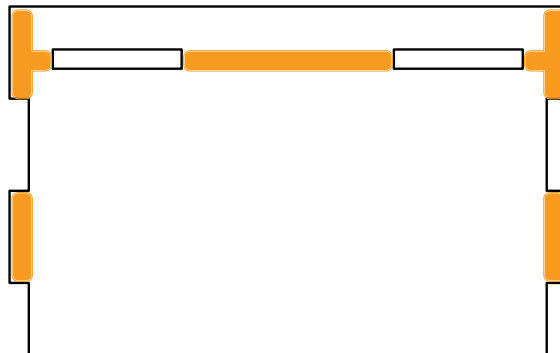
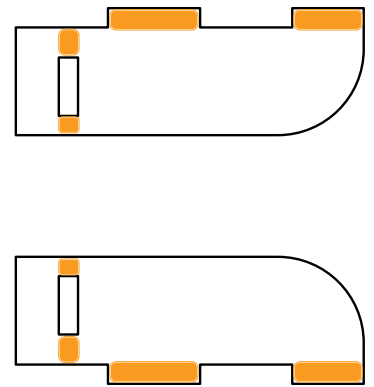
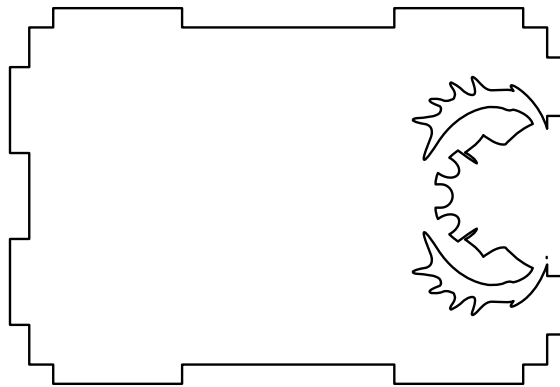
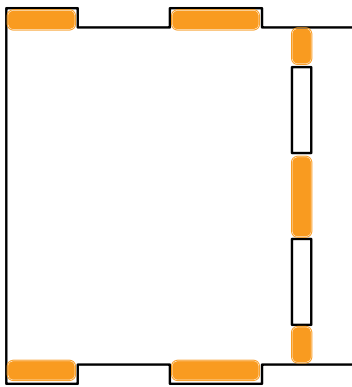
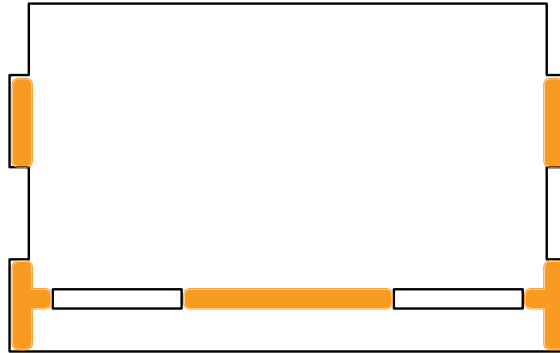



Sheet F2:

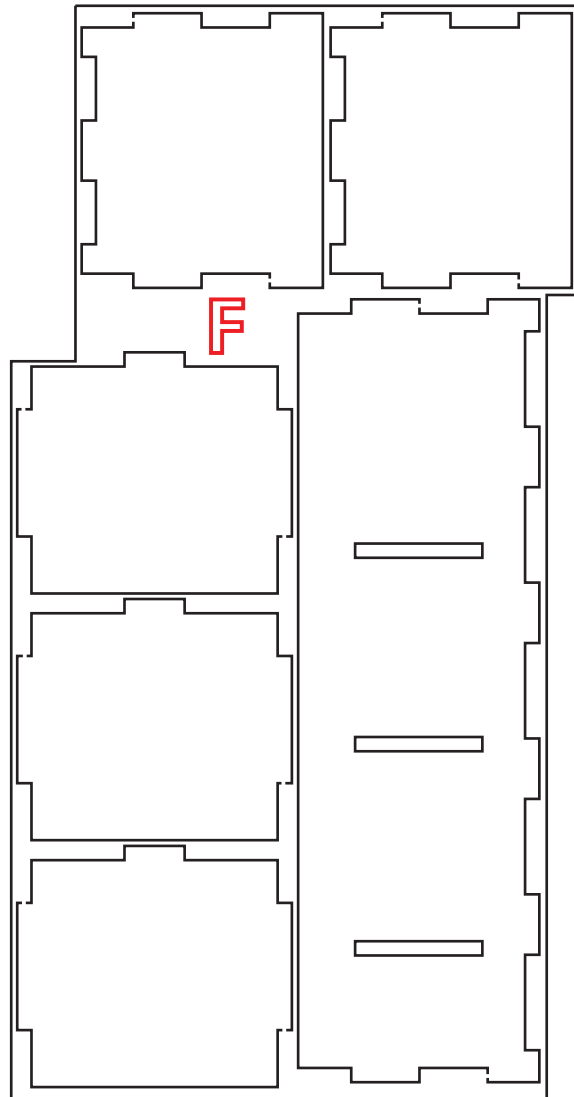

Sheet F1:

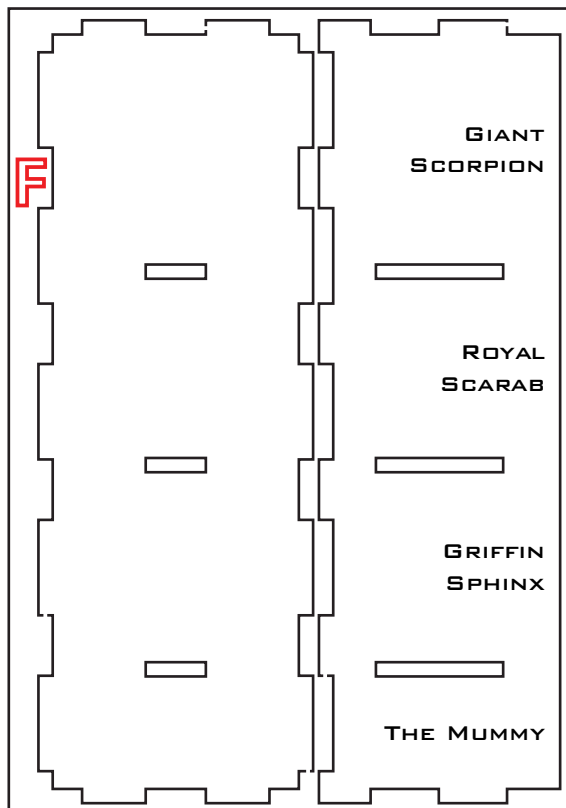



Recommended Assembly Sequence

1. Assemble middle pieces with dividers first
2. Glue and attach side 'wall' pieces
3. Glue and attach end pieces

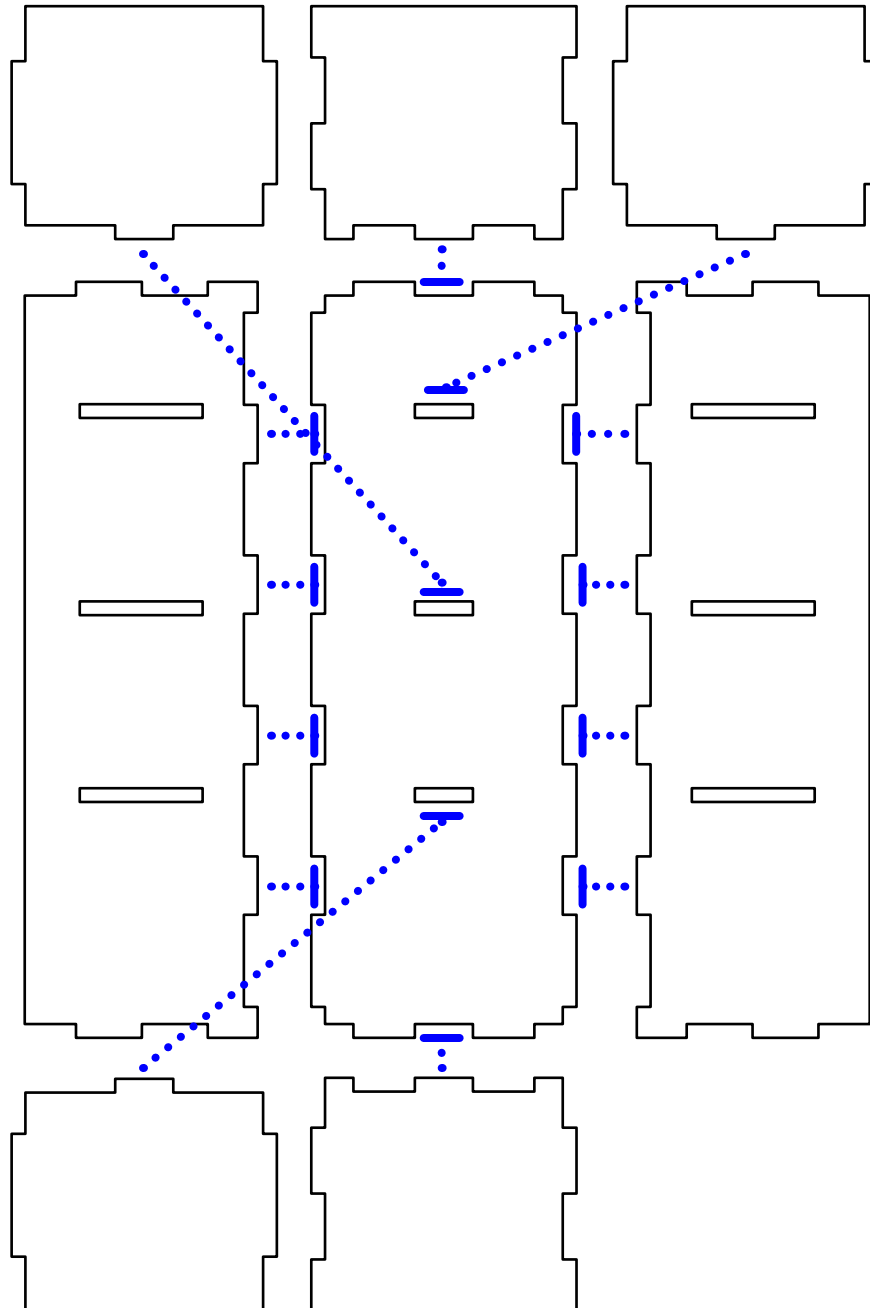

*Text side out



Glue Locations:

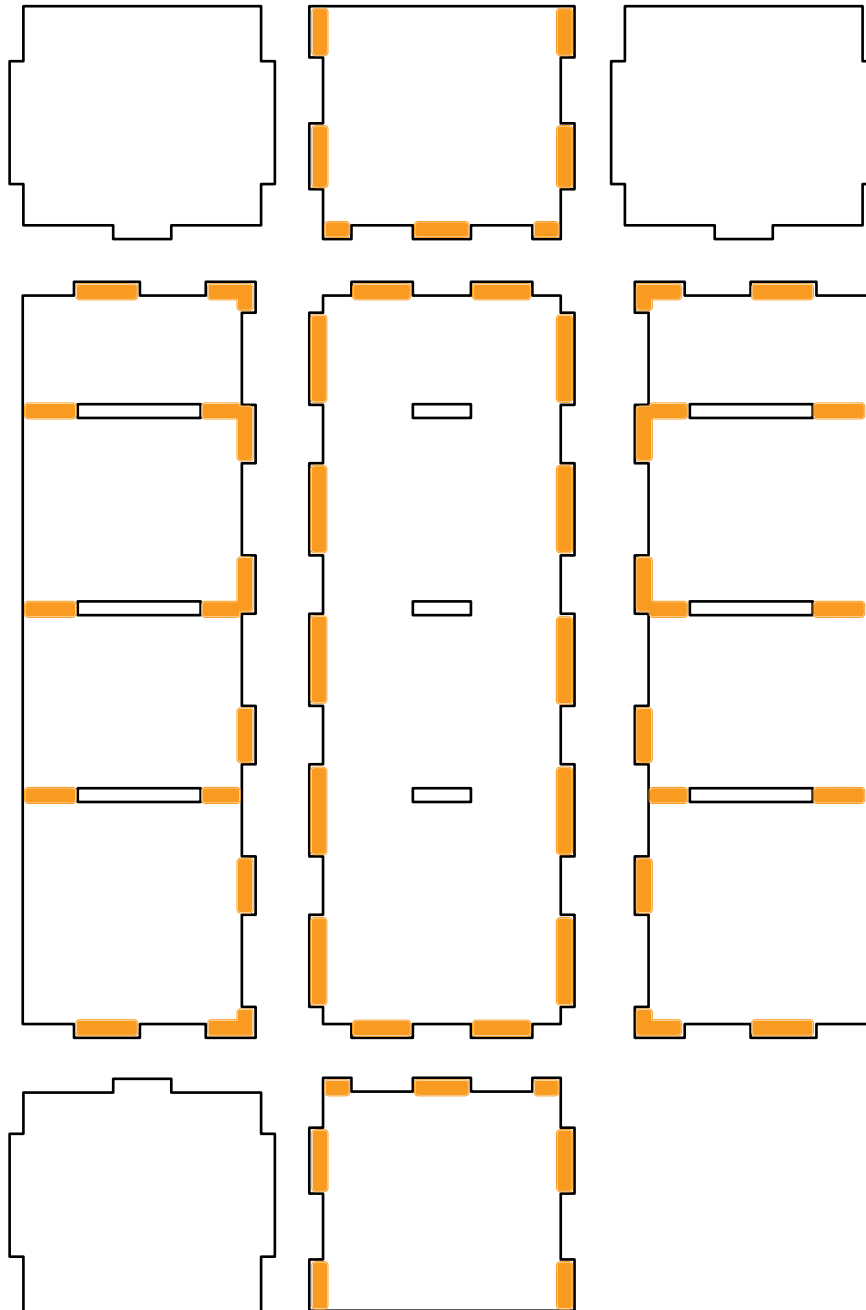

*Text side out



Sheet G1:

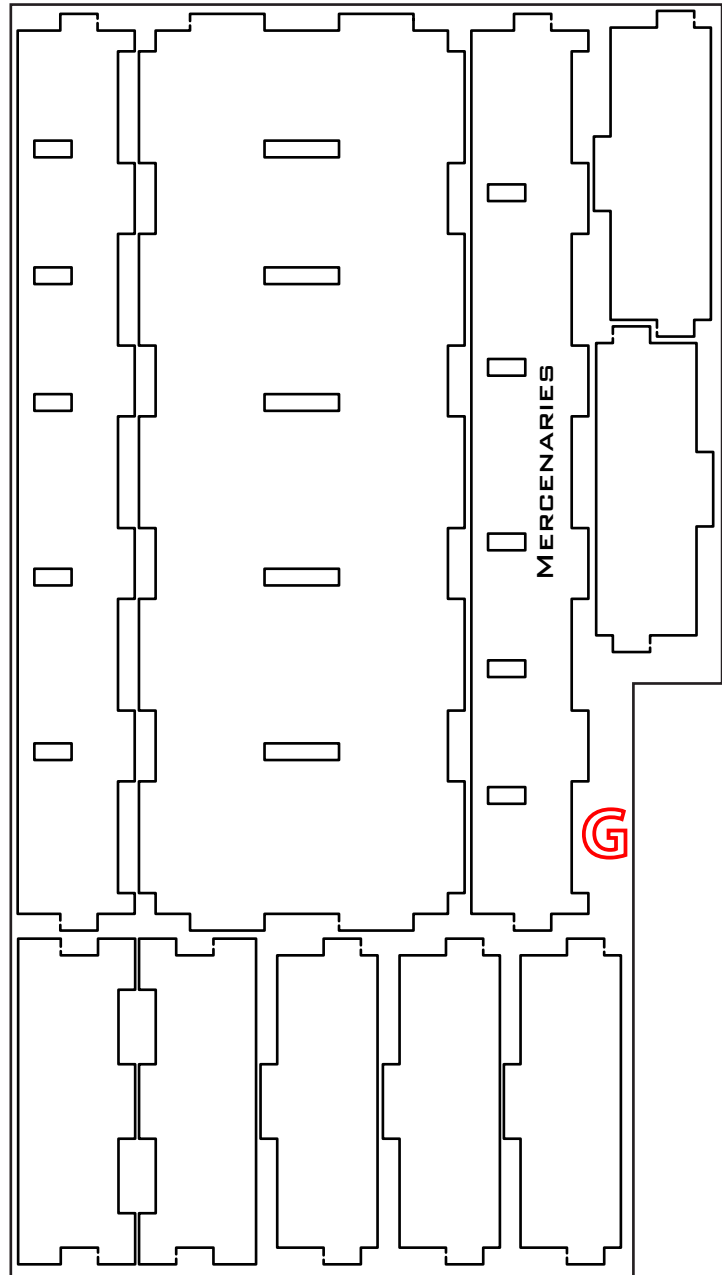



Recommended Assembly Sequence

1. Assemble middle pieces with dividers first
2. Glue and attach side 'wall' pieces
3. Glue and attach end pieces
- 4.

*Text side out

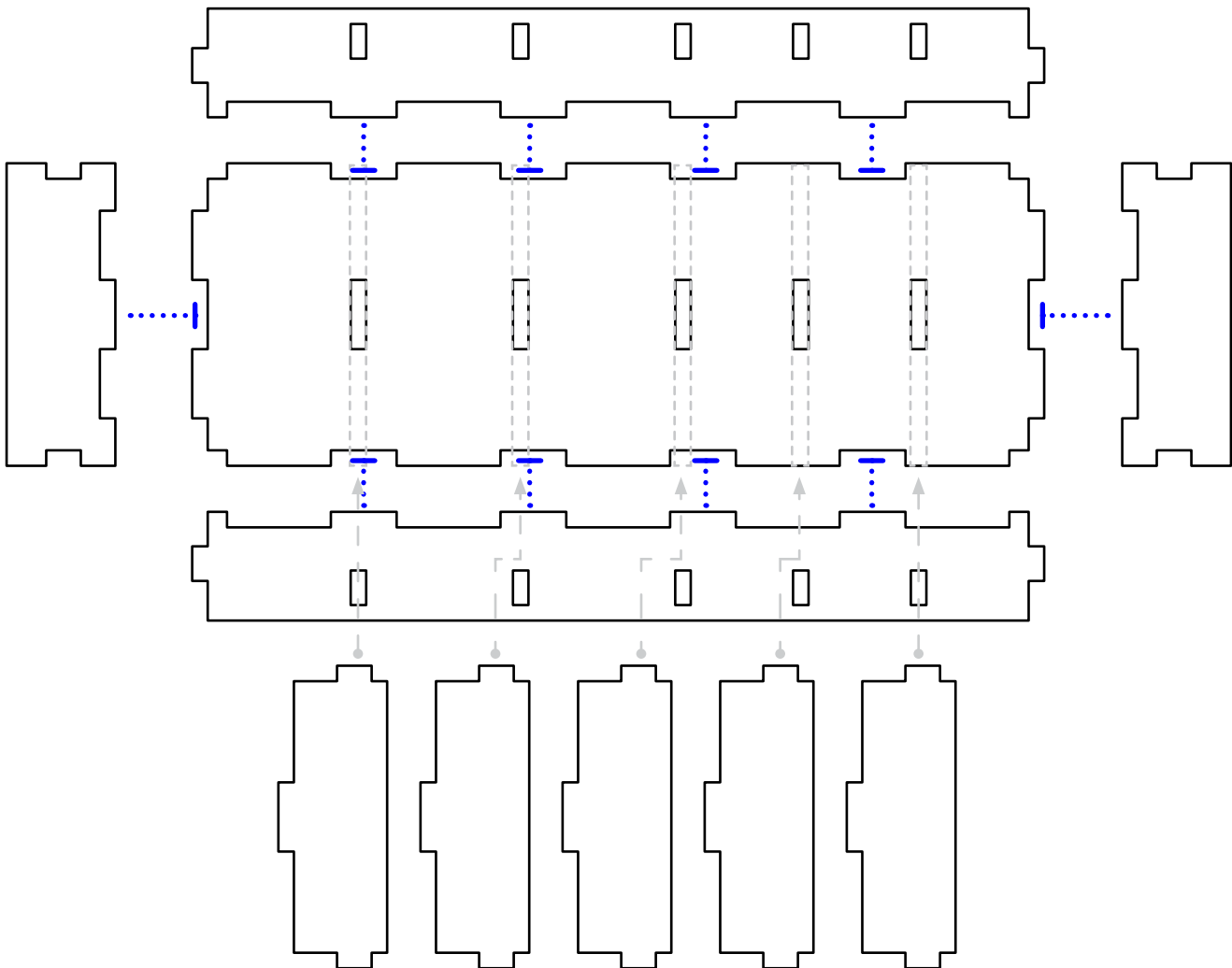



Glue Locations:

*Text side out

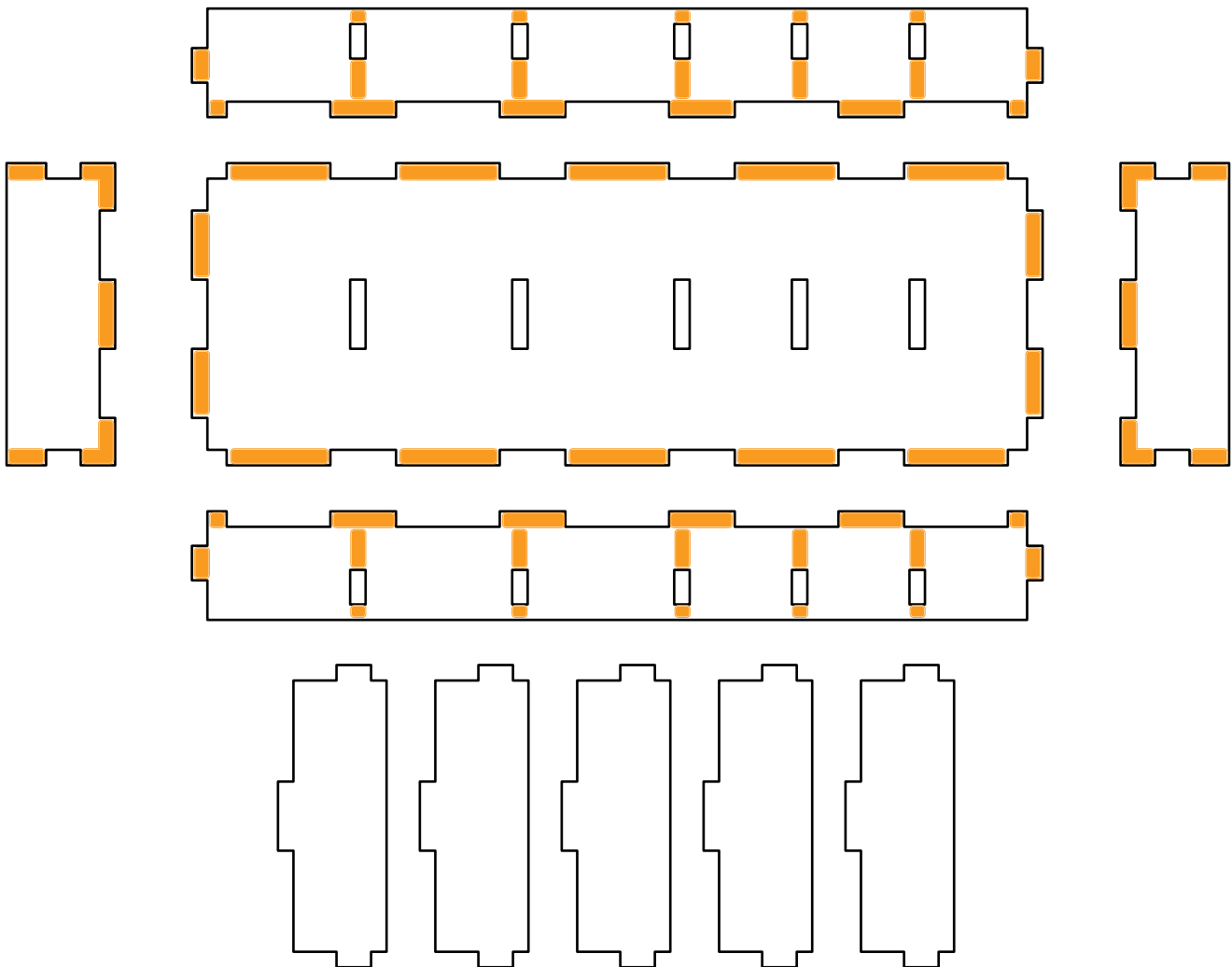



Sheet H2:

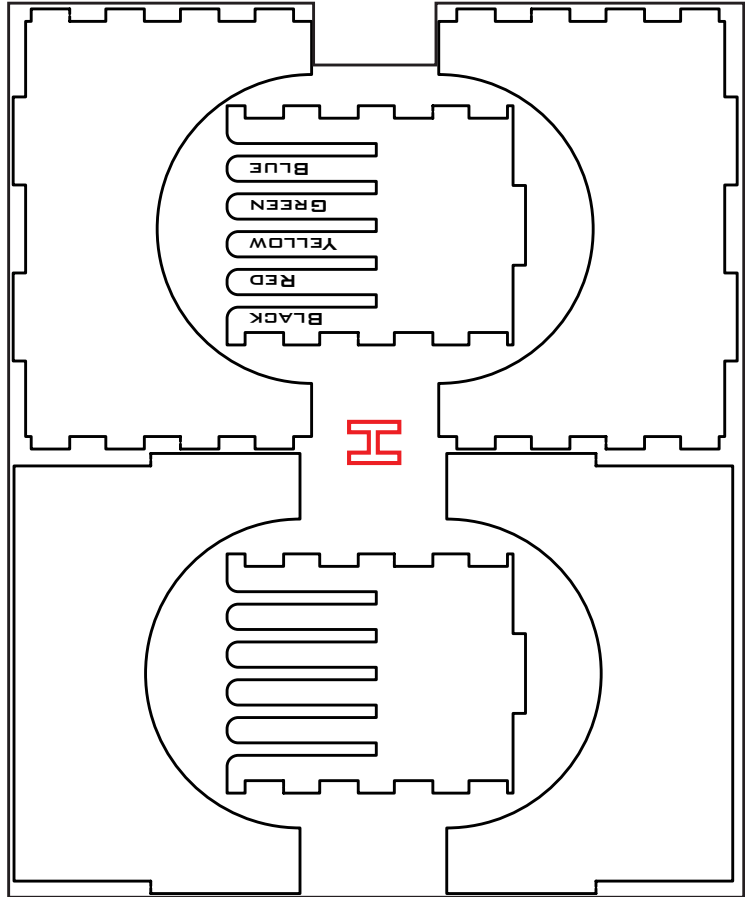

Sheet H1:

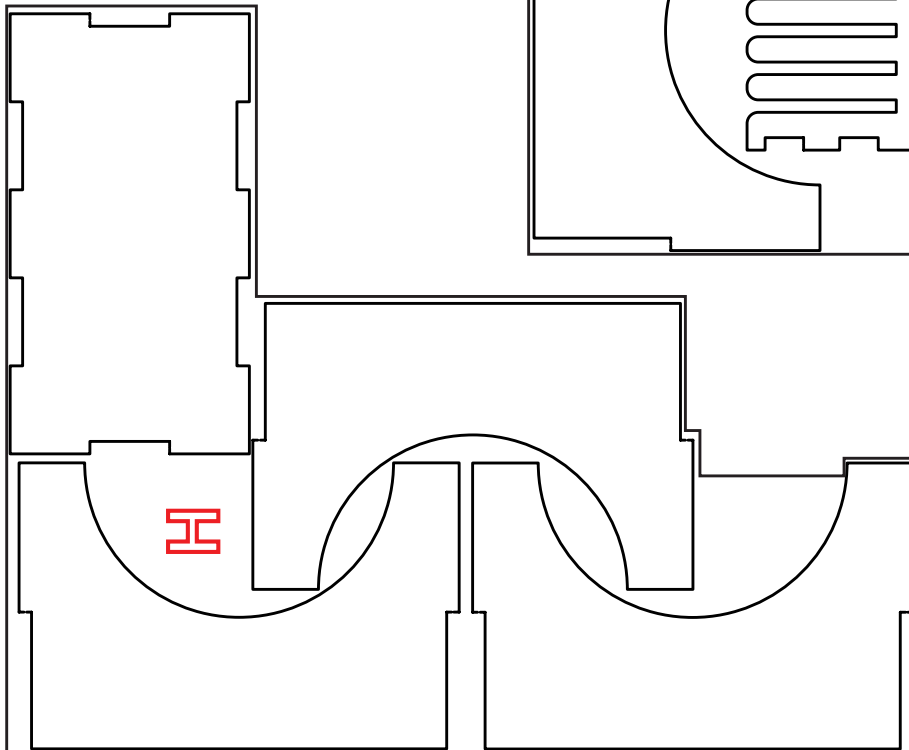



Recommended Assembly Sequence

1. Glue and attach side 'wall' pieces
2. Glue and attach end pieces
3. Slide in divider tabs

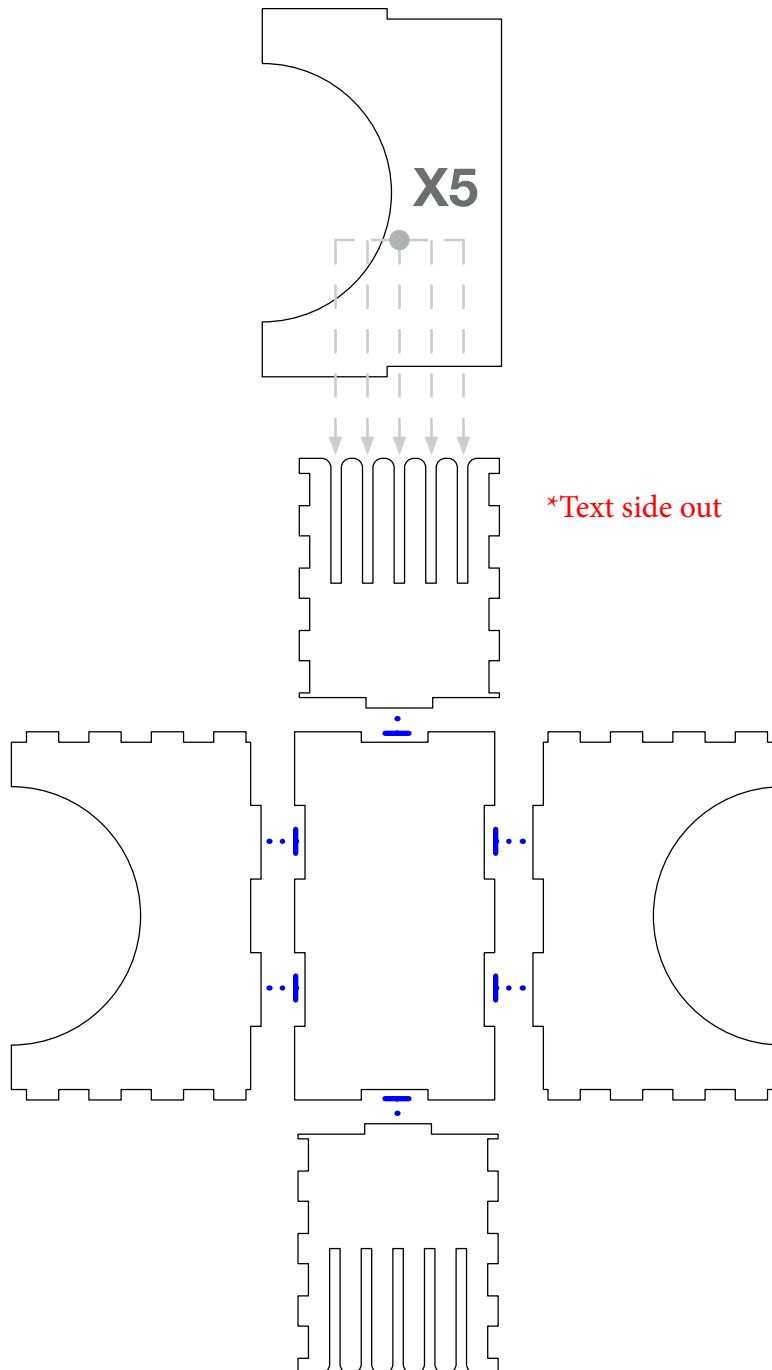



QUICK » START INSERT™ FOR
KEMET®



Glue Locations:

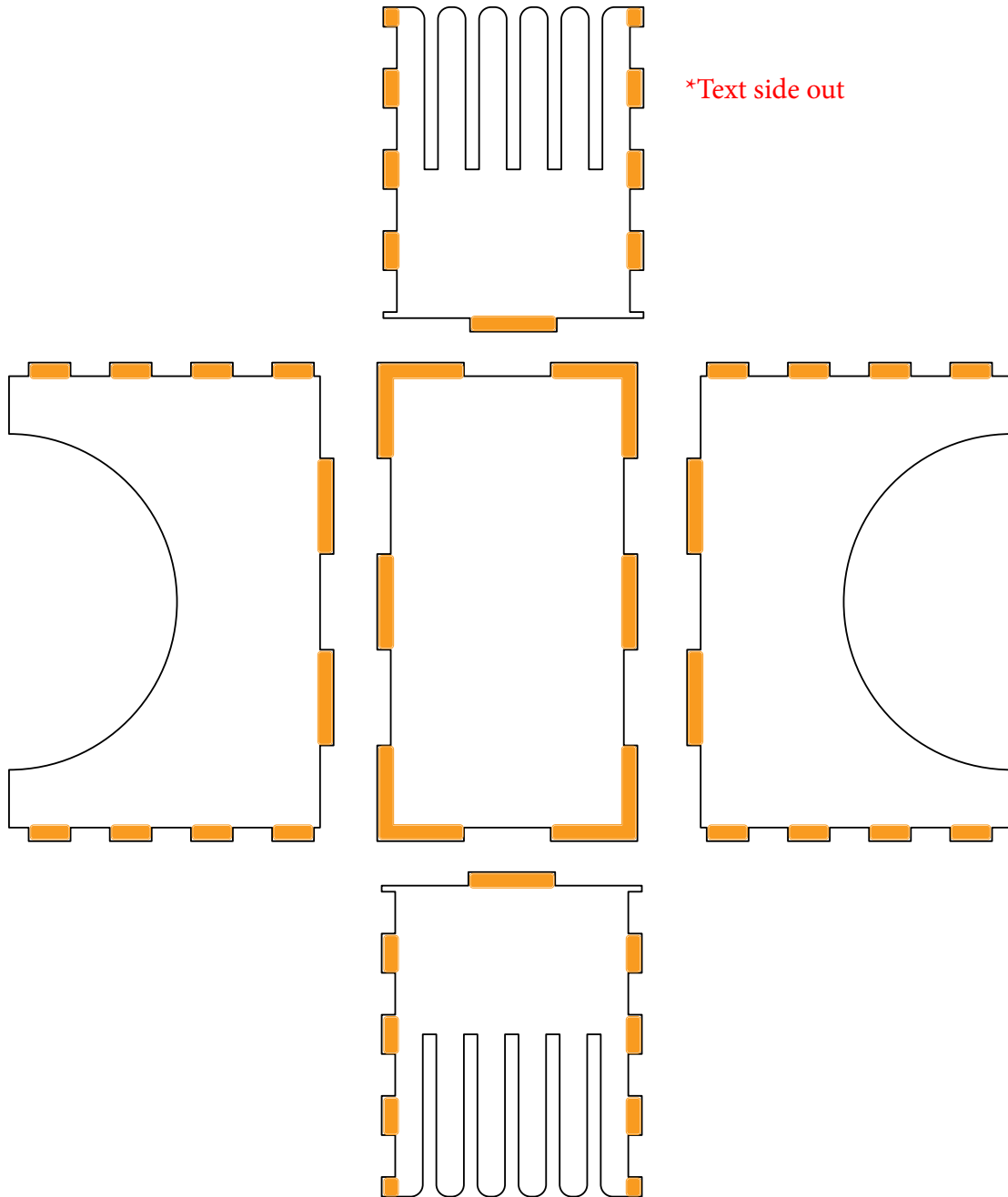

This Quick Start Insert is compatible with Kemet and its expansions. This is a non-licensed product. ALL RIGHTS RESERVED by their respective trademark holders. No challenge to any intellectual property rights is intended or implied by representations of compatibility and no endorsements of any of our products by any other company is implied or represented.



Sheet I1:





Recommended Assembly Sequence

1. Assemble middle pieces with dividers first
2. Glue and attach side 'wall' pieces
3. Glue and attach end pieces

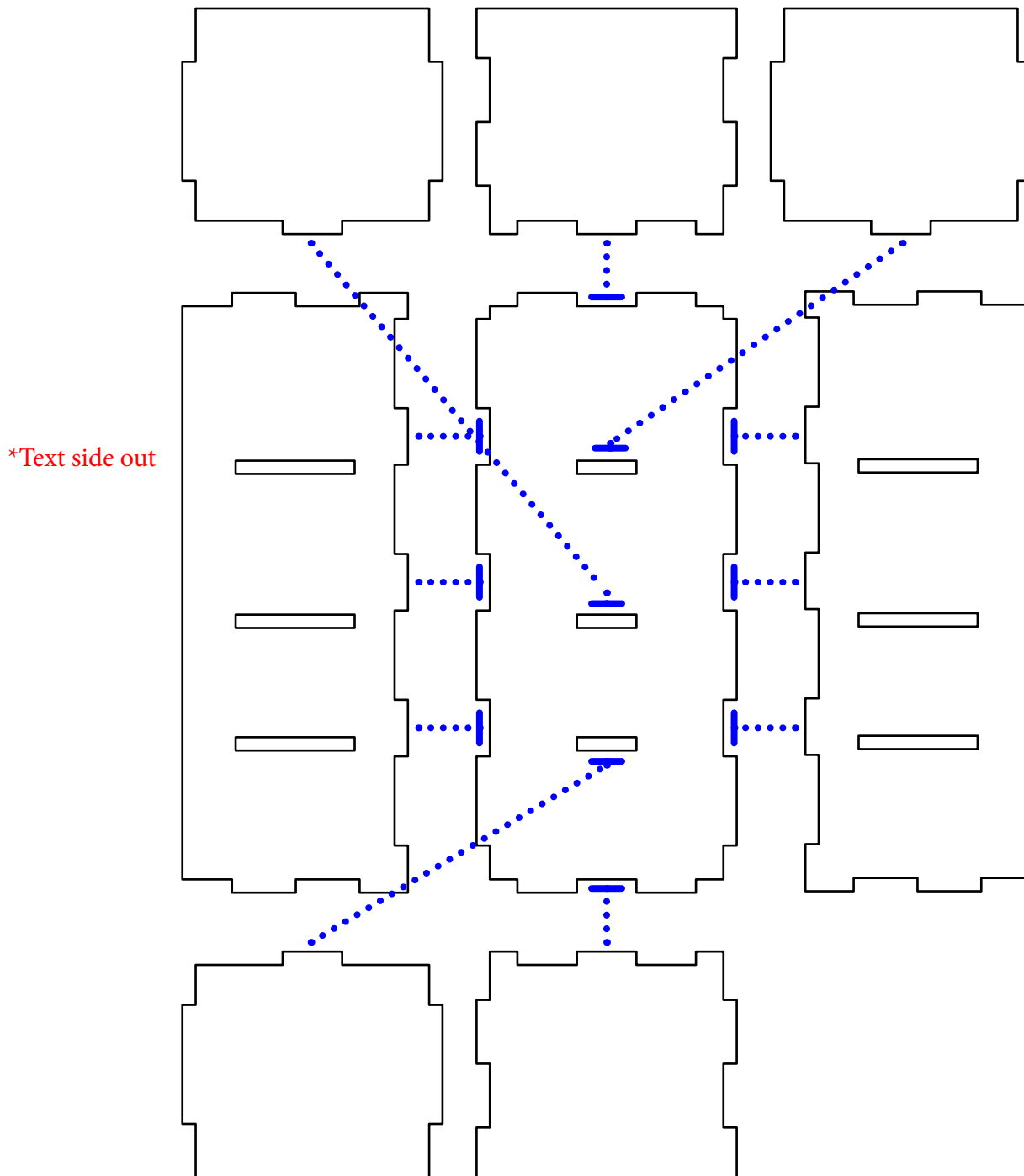



Glue Locations:

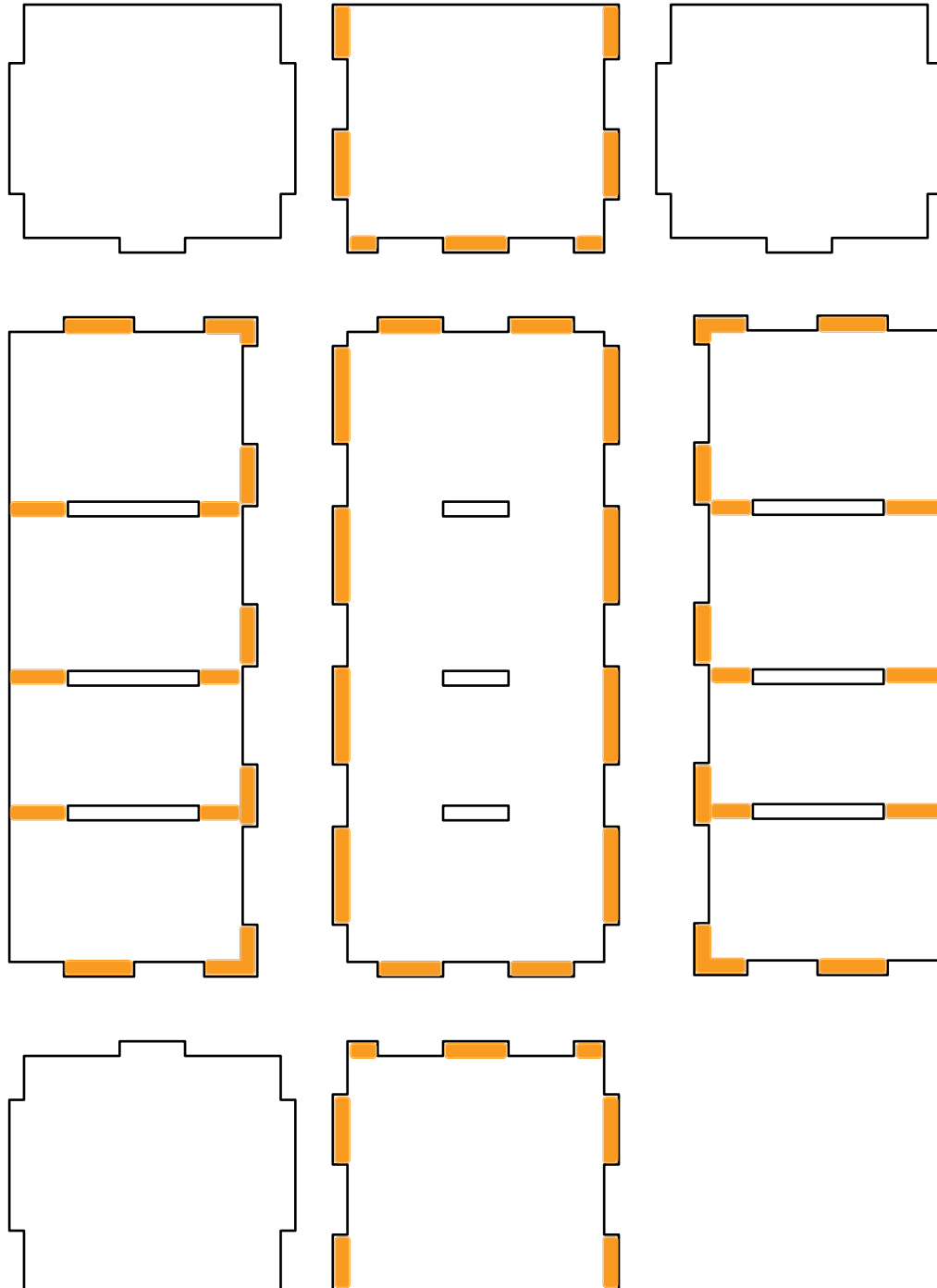

*Text side out



Sheet J1:

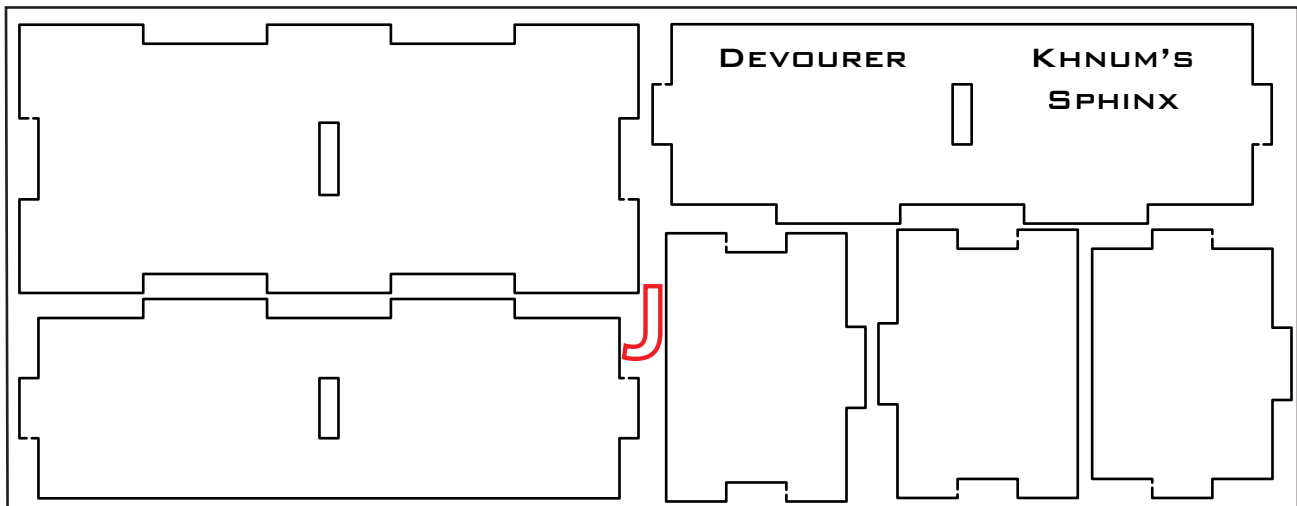



Recommended Assembly Sequence

1. Assemble middle divider piece first
2. Glue and attach side 'wall' pieces
3. Glue and attach end pieces

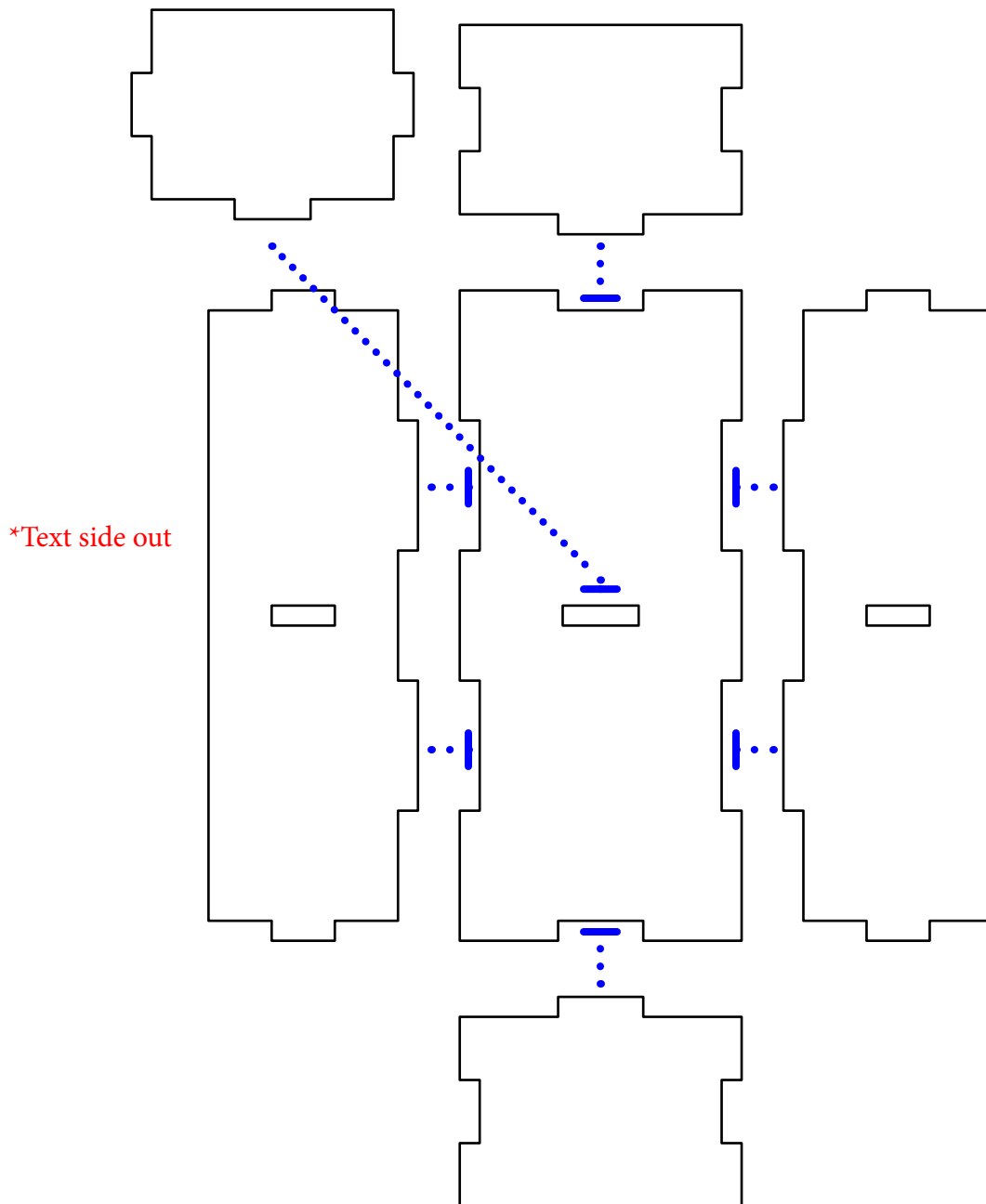



Glue Locations:

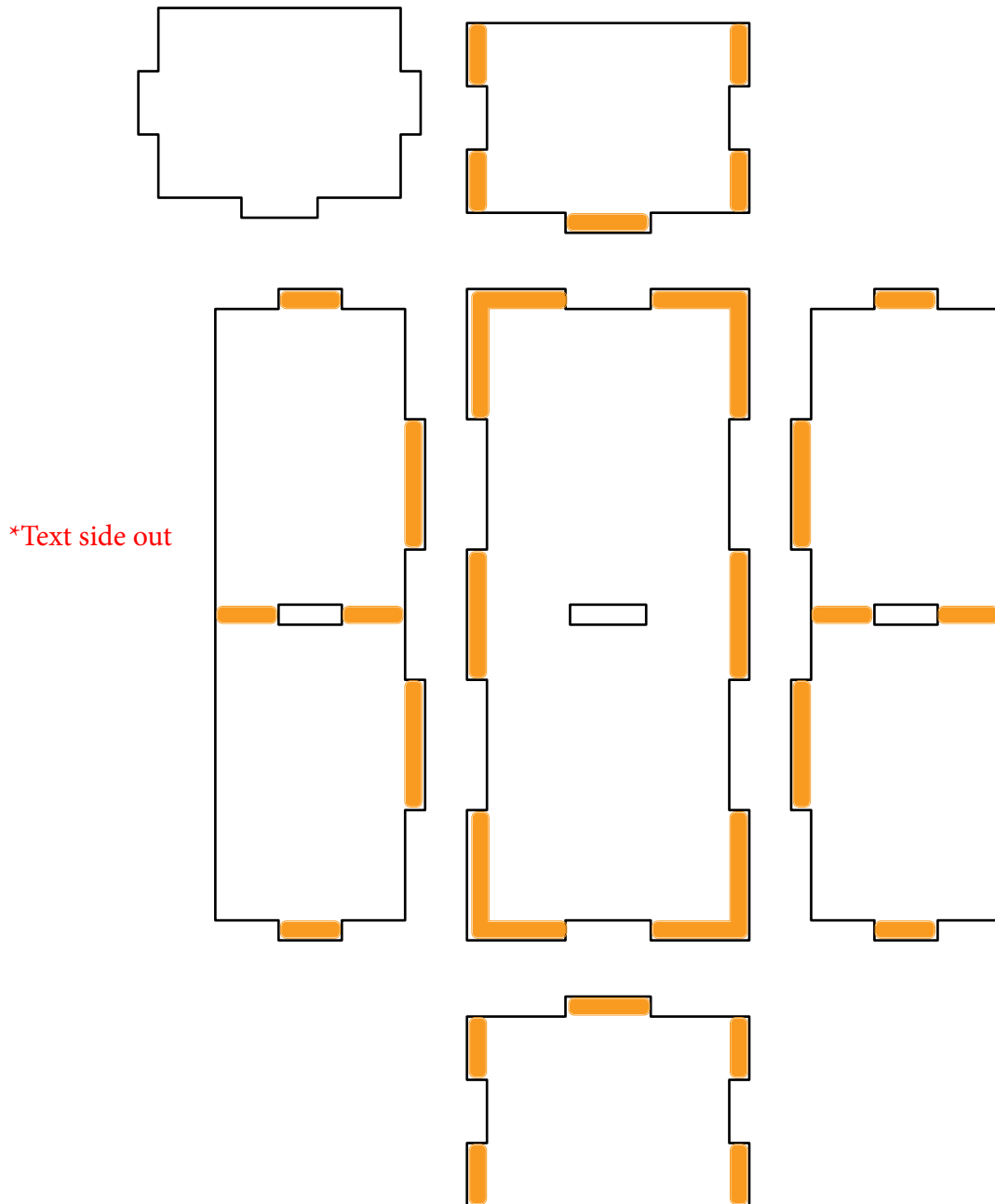



Sheet K1:

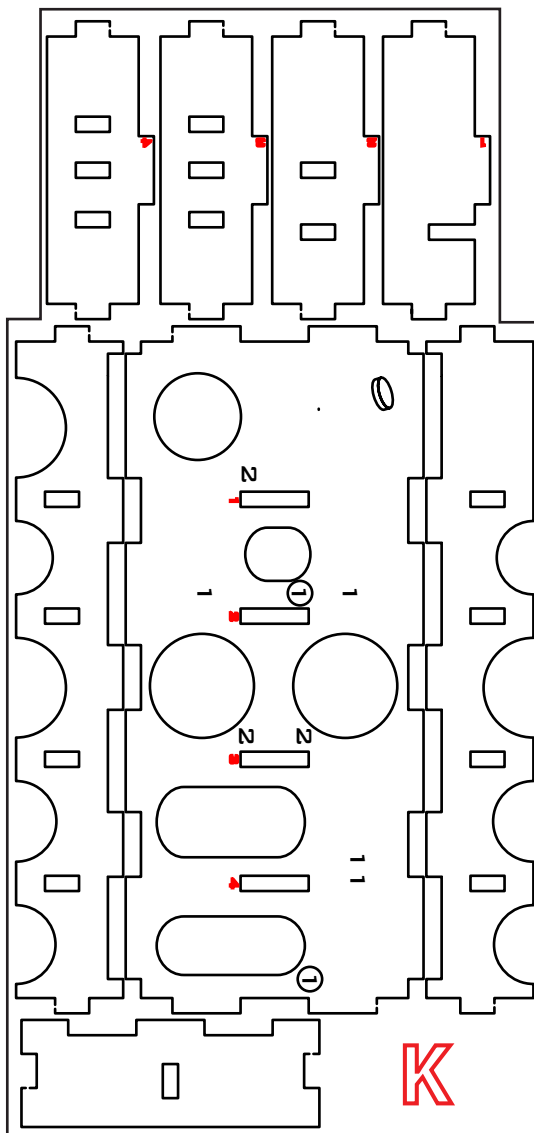

Sheet K2:

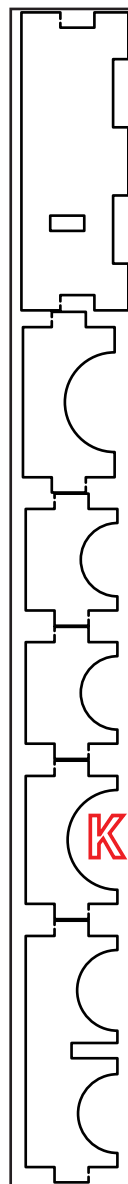



Recommended Assembly Sequence

1. Assemble middle pieces with dividers first
2. Glue and attach side 'wall' pieces
3. Glue and attach end pieces

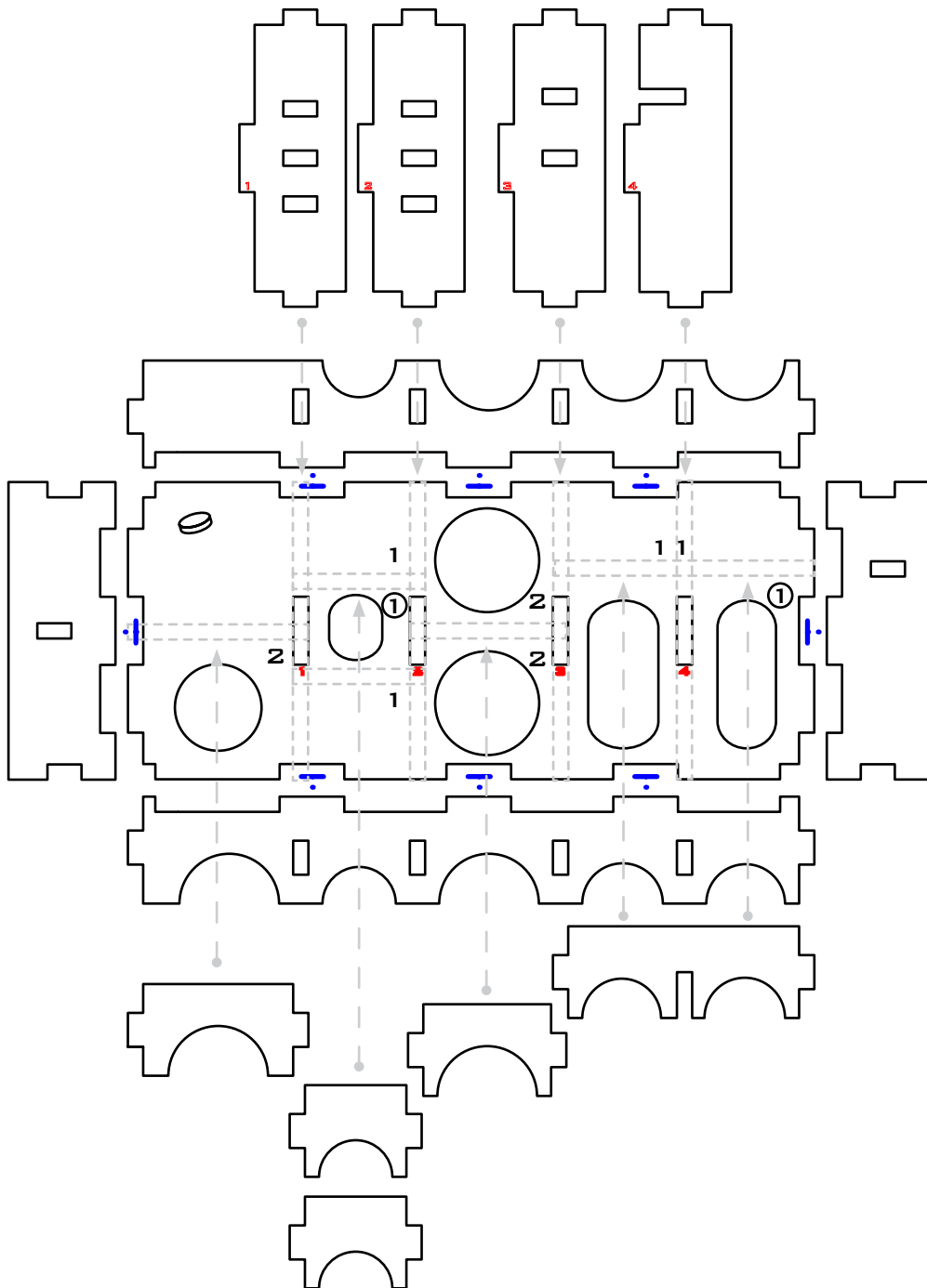



Glue Locations:

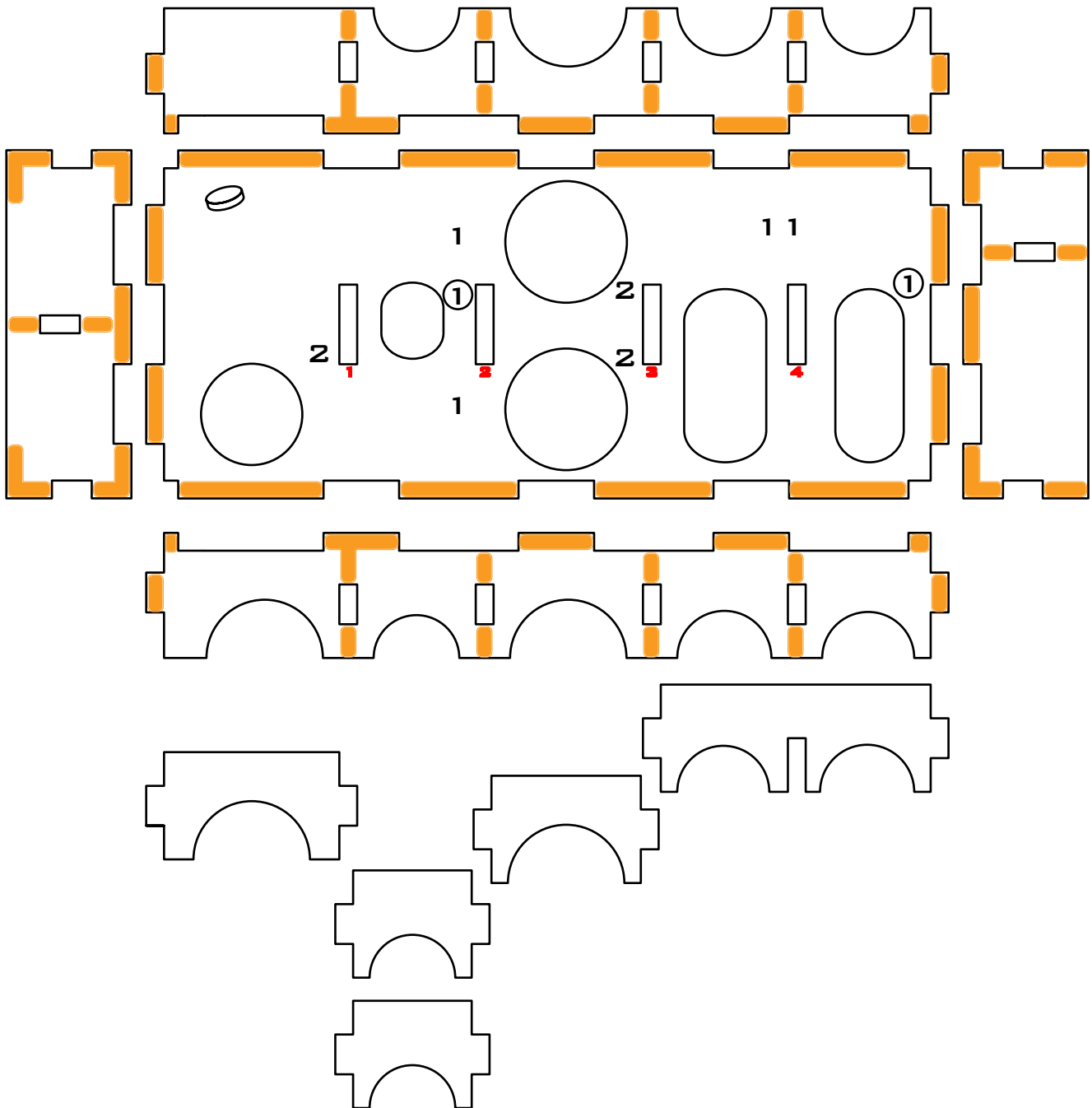



QUICK » START INSERT™ FOR
KEMET®



Sheet L1:

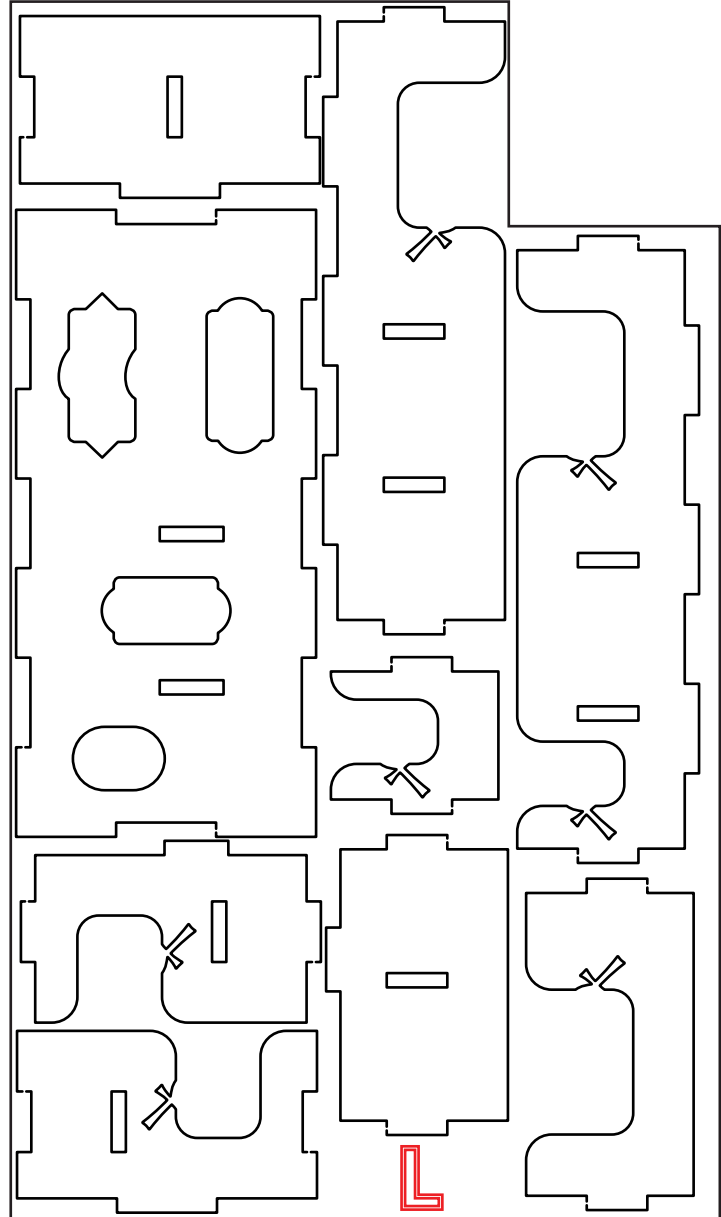

This Quick Start Insert is compatible with Kemetic and its expansions. This is a non-licensed product. ALL RIGHTS RESERVED by their respective trademark holders. No challenge to any intellectual property rights is intended or implied by representations of compatibility and no endorsements of any of our products by any other company is implied or represented.



Recommended Assembly Sequence

1. Assemble middle pieces with dividers first
2. Glue and attach side 'wall' pieces
3. Glue and attach end pieces

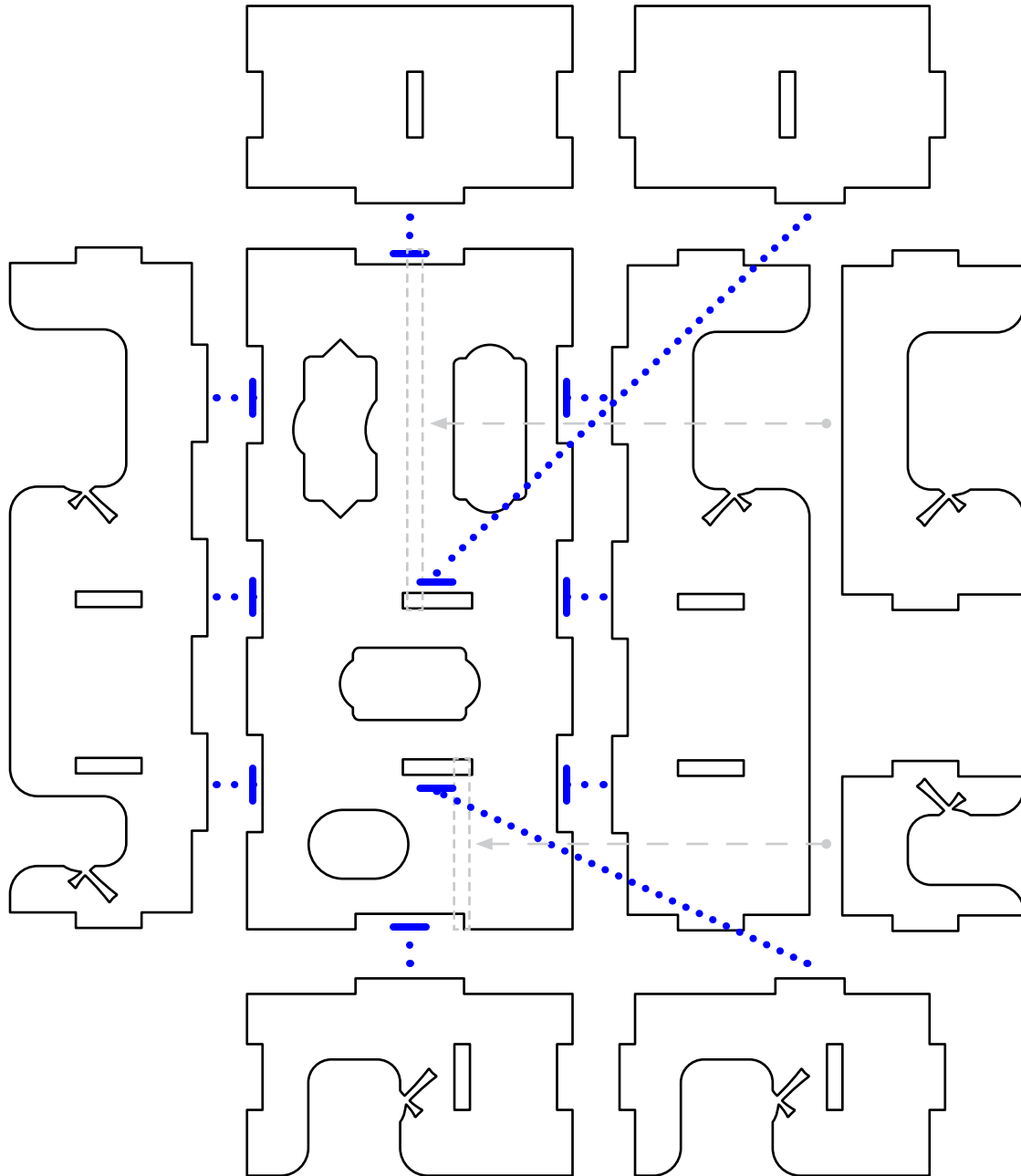



Glue Locations:

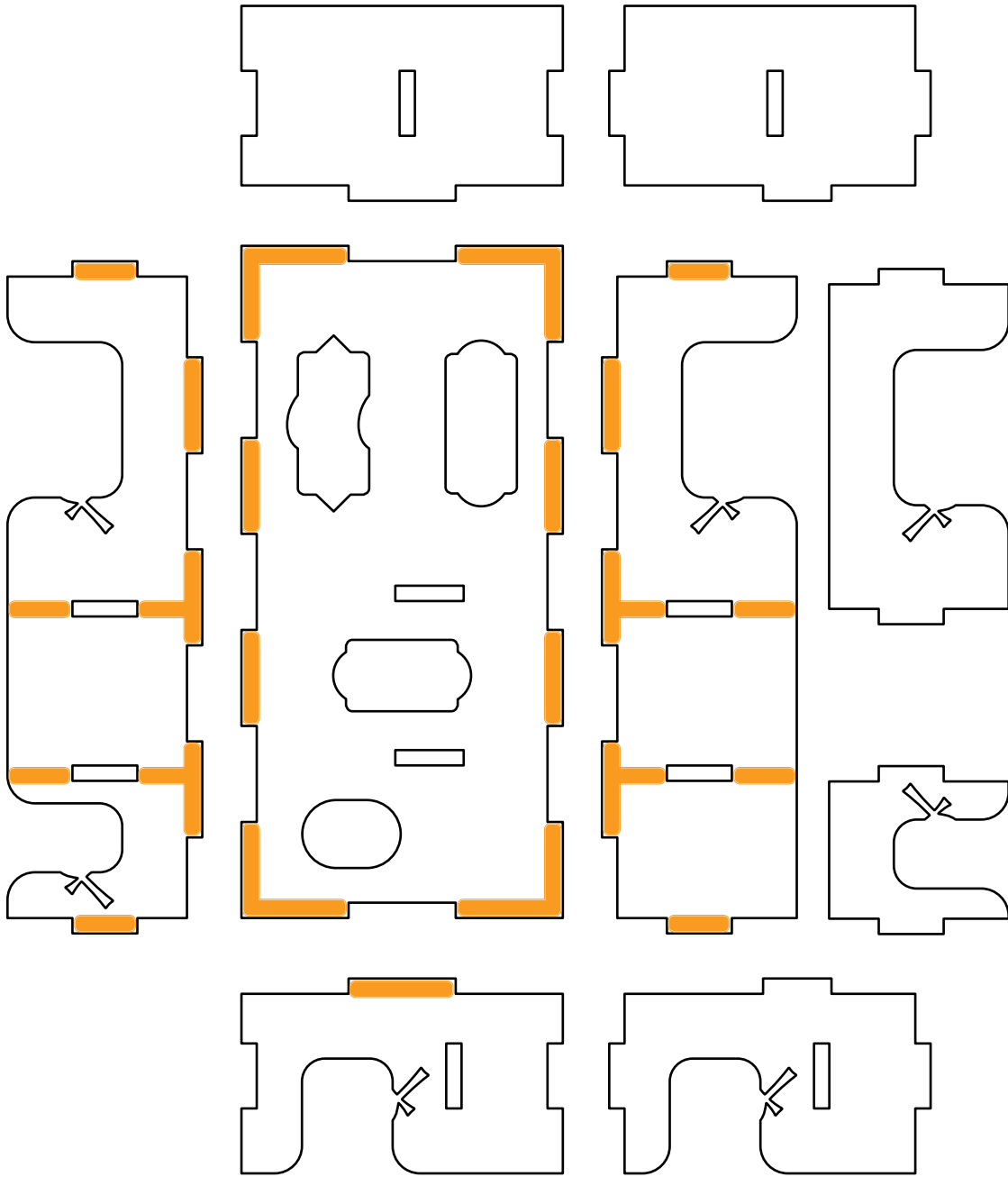



Sheet M1:

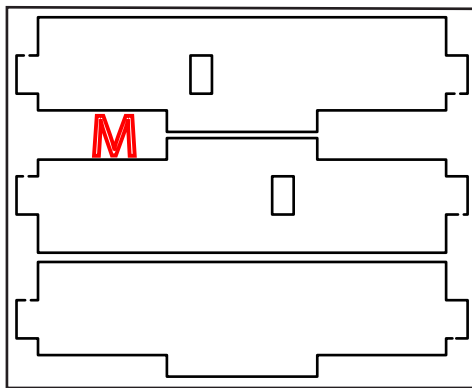

Sheet M1:

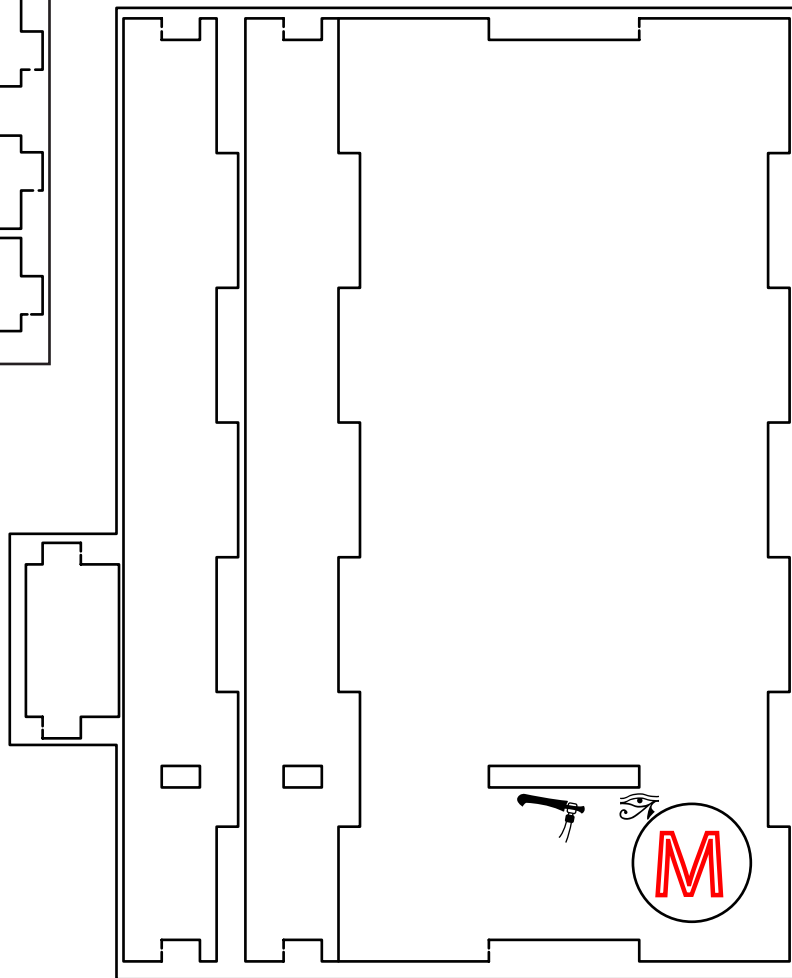



Recommended Assembly Sequence

1. Assemble middle pieces with divider first
2. Glue and attach side 'wall' pieces
3. Glue and attach end pieces

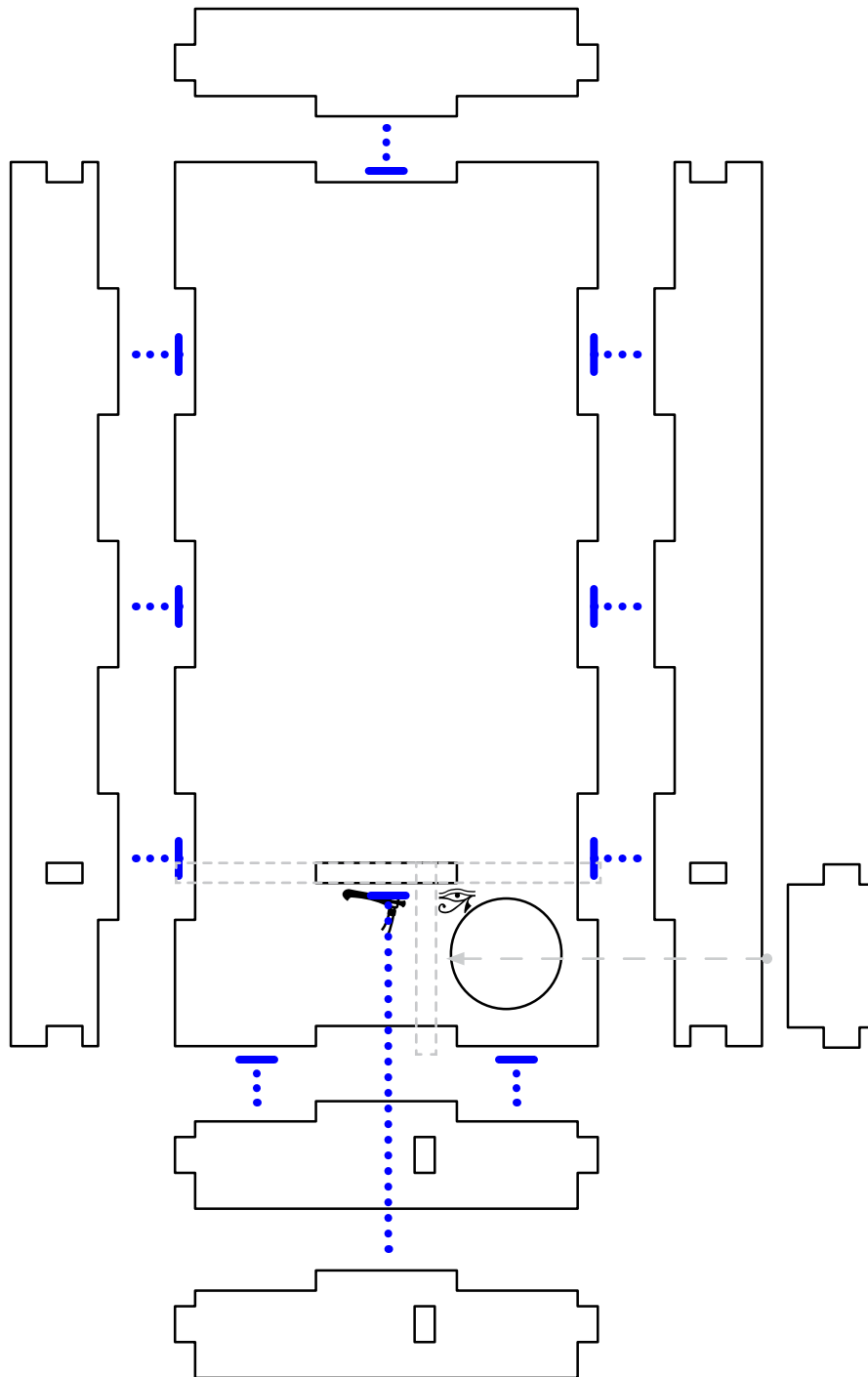



QUICK » START INSERT™ FOR
KEMET®



Glue Locations:

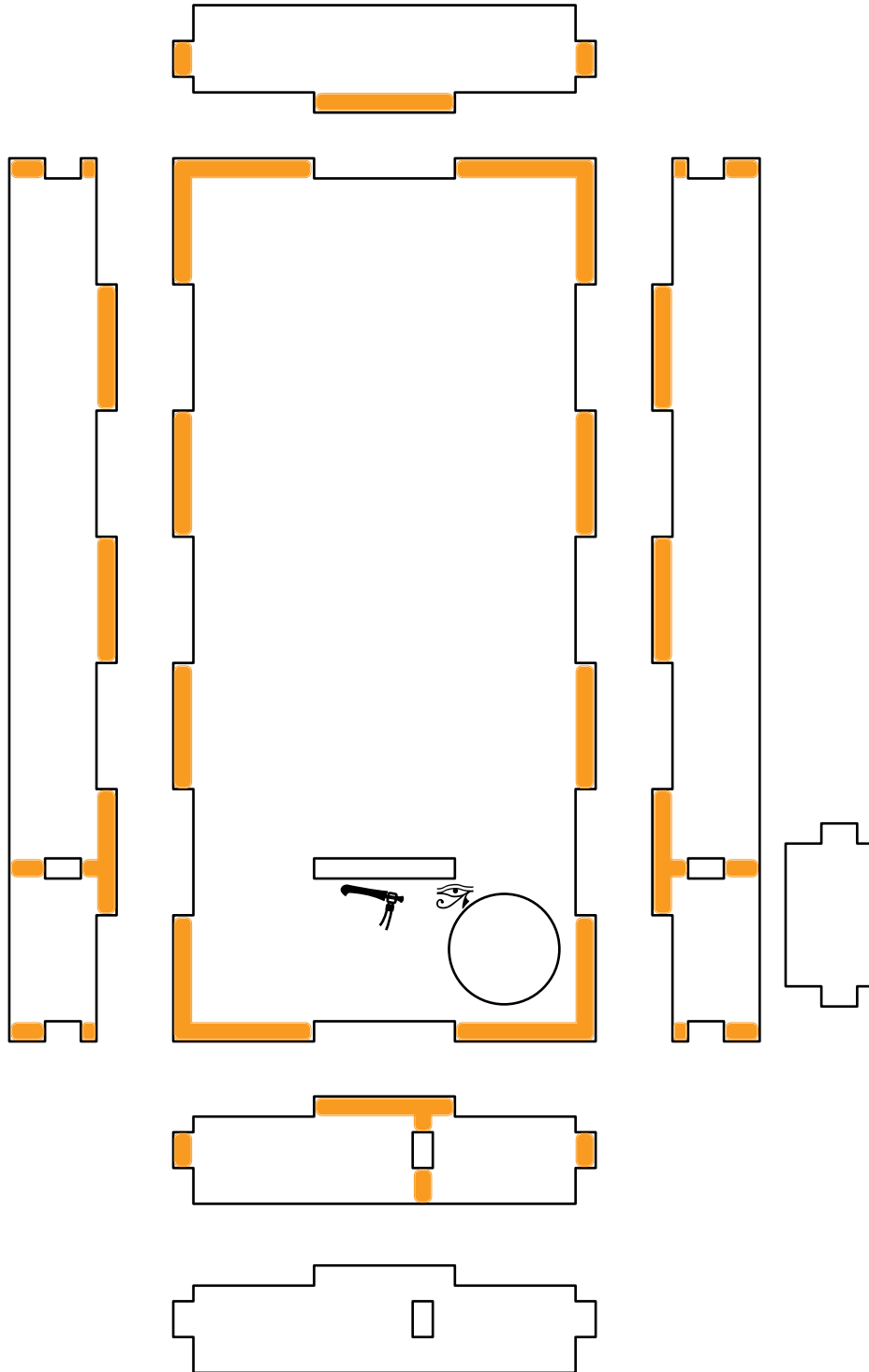

This Quick Start Insert is compatible with Kemetic and its expansions. This is a non-licensed product. ALL RIGHTS RESERVED by their respective trademark holders. No challenge to any intellectual property rights is intended or implied by representations of compatibility and no endorsements of any of our products by any other company is implied or represented.



**QUICK » START INSERT™ FOR
KEMET®**



Sheet N1:

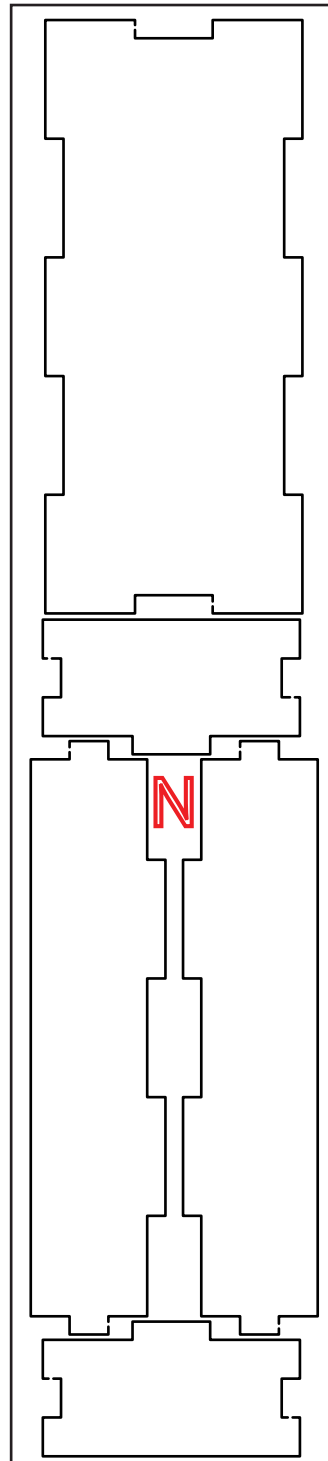

This Quick Start Insert is compatible with Kemet and its expansions. This is a non-licensed product. ALL RIGHTS RESERVED by their respective trademark holders. No challenge to any intellectual property rights is intended or implied by representations of compatibility and no endorsements of any of our products by any other company is implied or represented.



QUICK » START INSERT™ FOR
KEMET®



Recommended Assembly Sequence

1. Glue and attach side 'wall' pieces
2. Glue and attach end pieces

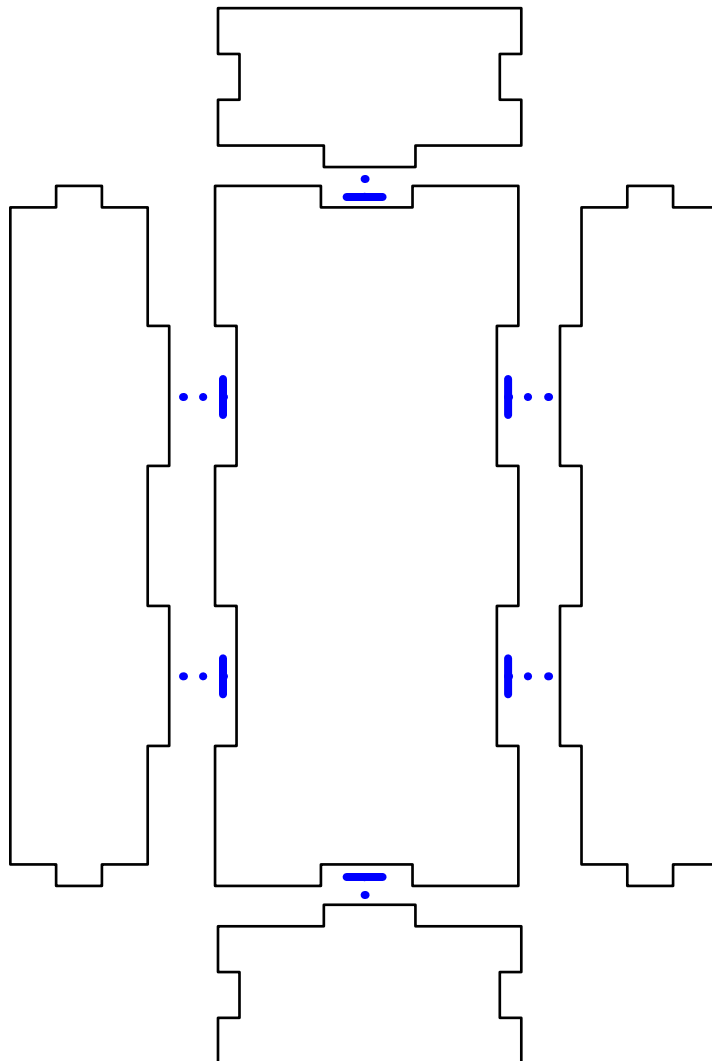

This Quick Start Insert is compatible with Kemet and its expansions. This is a non-licensed product. ALL RIGHTS RESERVED by their respective trademark holders. No challenge to any intellectual property rights is intended or implied by representations of compatibility and no endorsements of any of our products by any other company is implied or represented.



Glue Locations:

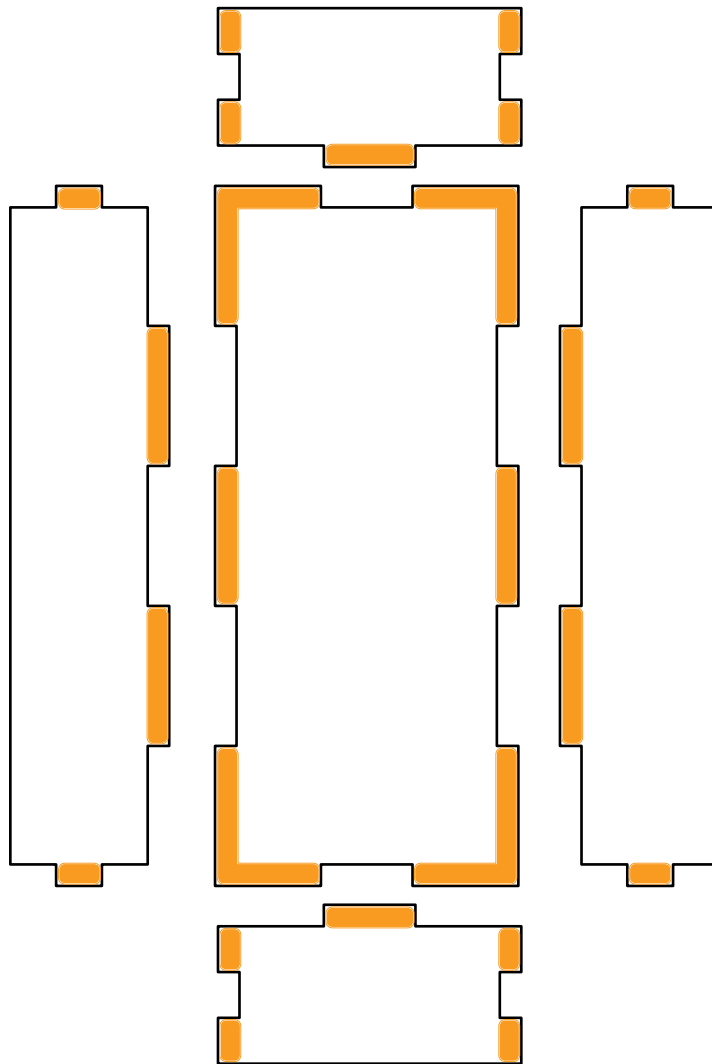



QUICK » START INSERT™ FOR
KEMET®

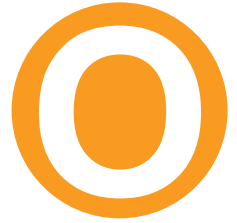

Sheet 01:

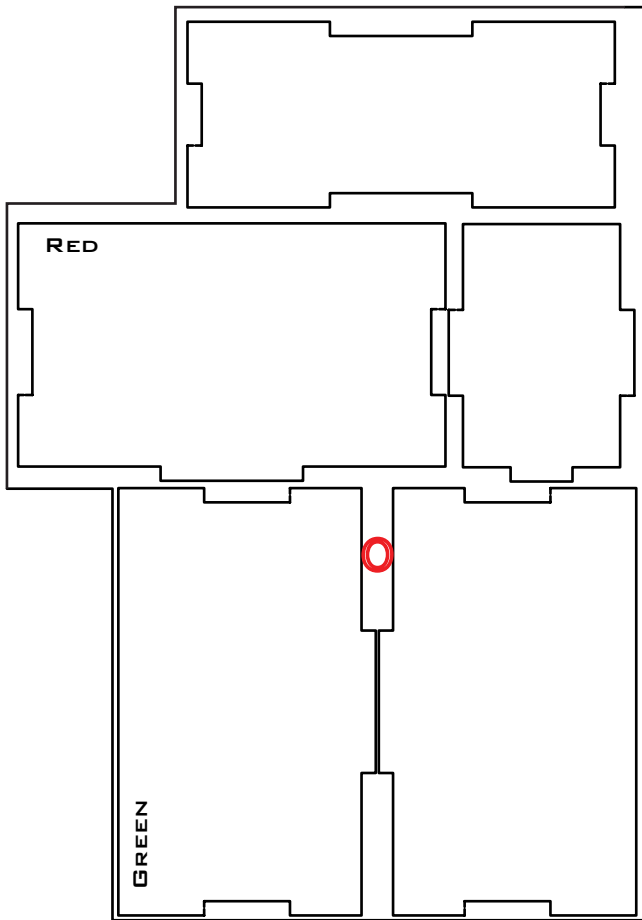

Sheet 02:

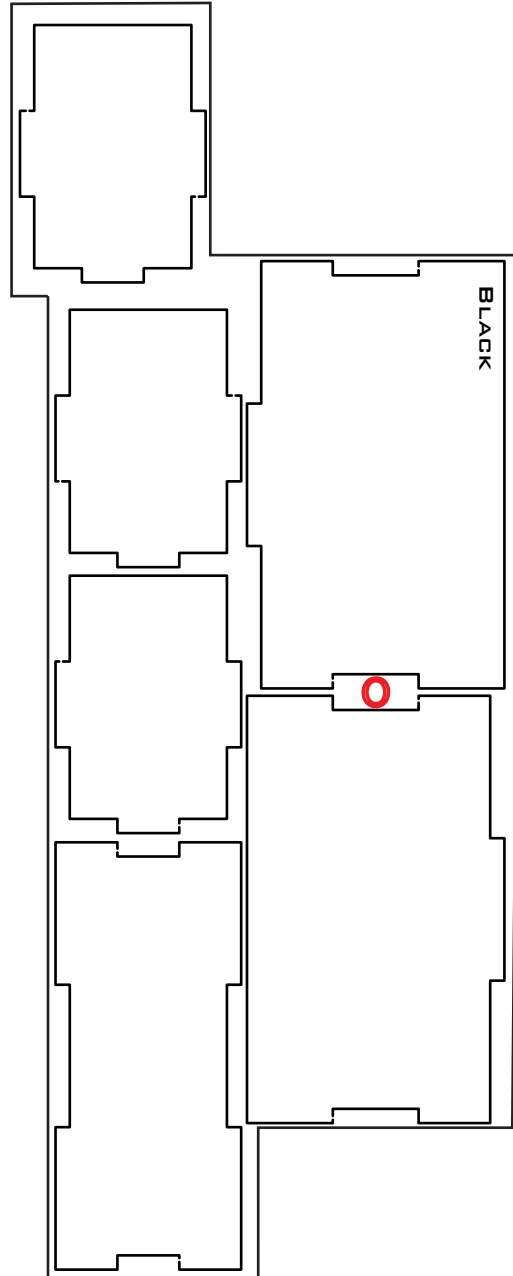

This Quick Start Insert is compatible with Kemet and its expansions. This is a non-licensed product. ALL RIGHTS RESERVED by their respective trademark holders. No challenge to any intellectual property rights is intended or implied by representations of compatibility and no endorsements of any of our products by any other company is implied or represented.



Sheet O3:

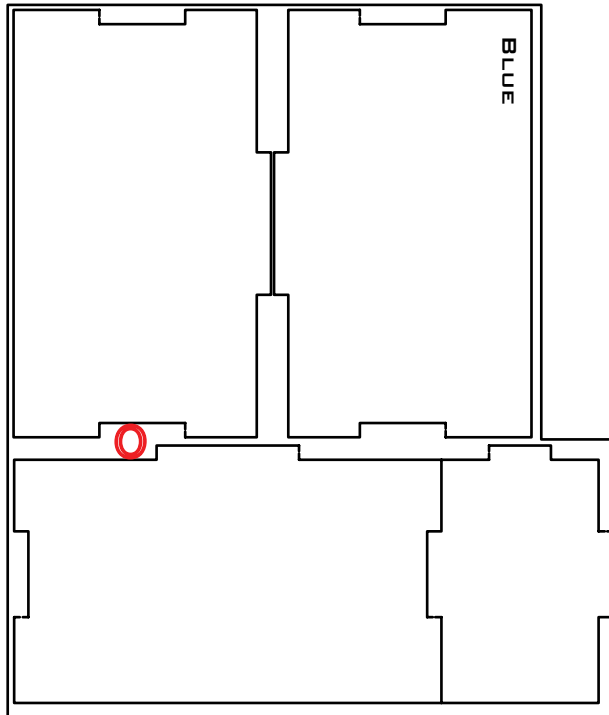

Sheet O4:

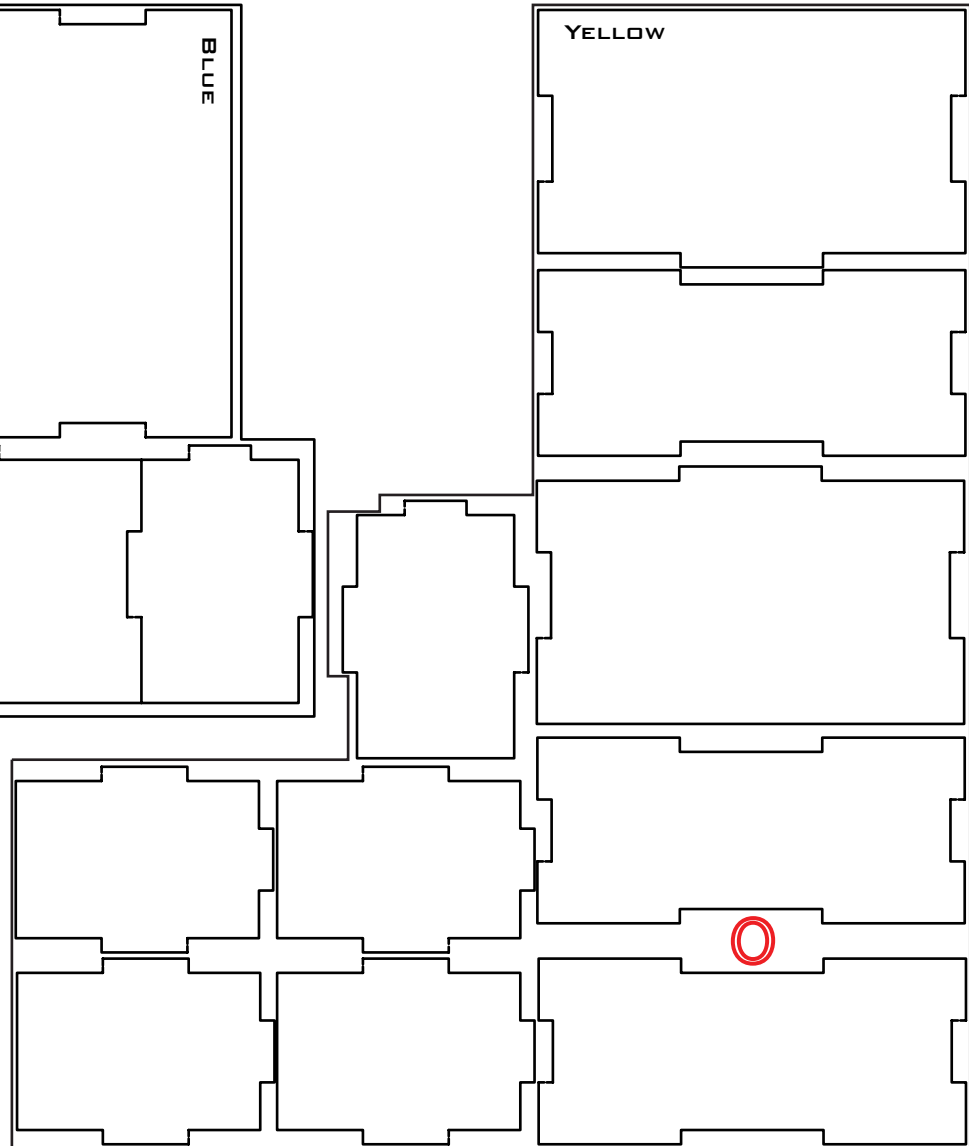

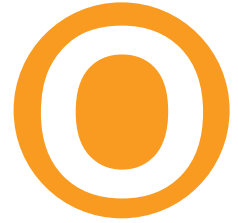

Recommended Assembly Sequence

1. Glue and attach side 'wall' pieces
2. Glue and attach end pieces

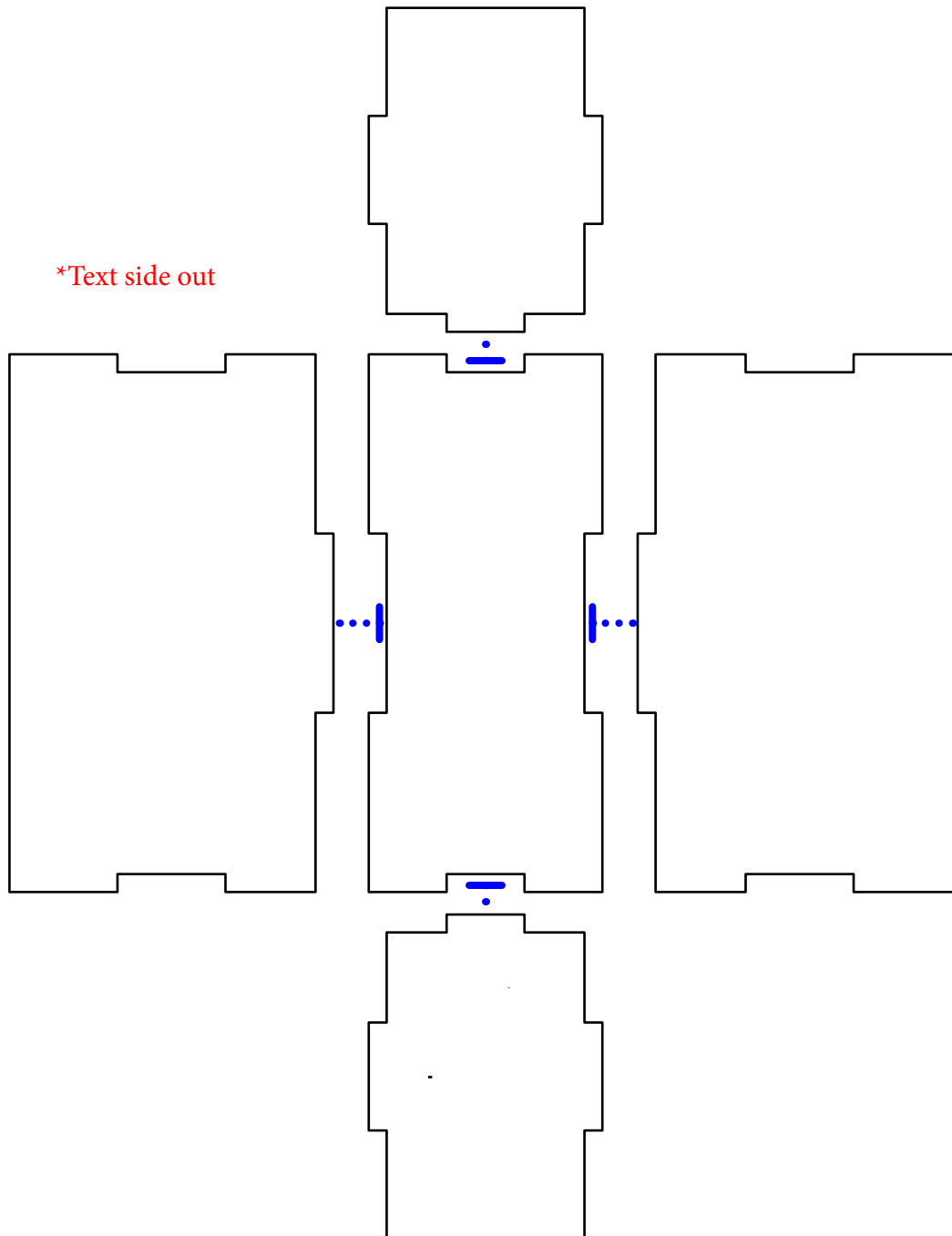



Glue Locations:

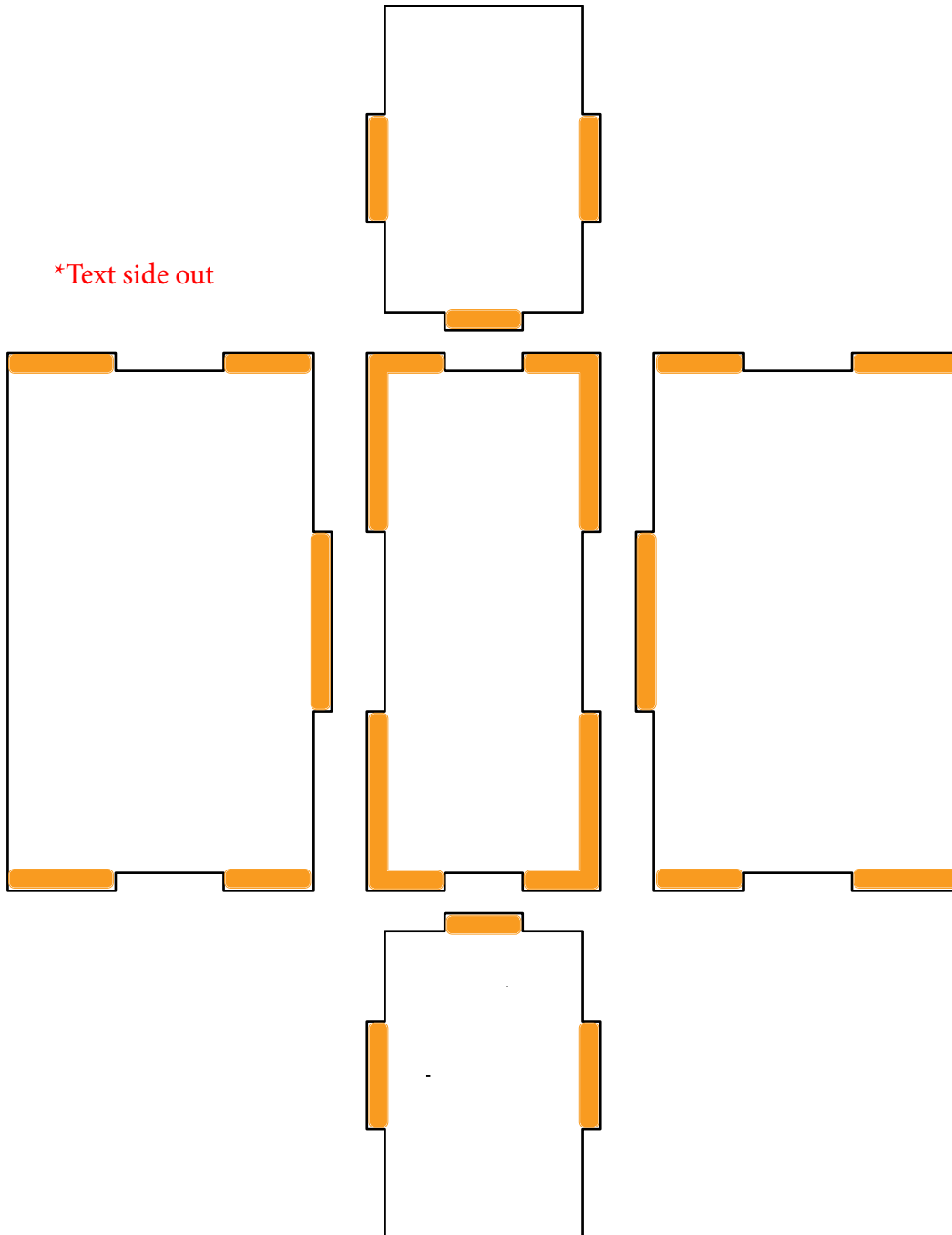



QUICK START INSERT™ FOR KEMET®

Bottom Layer

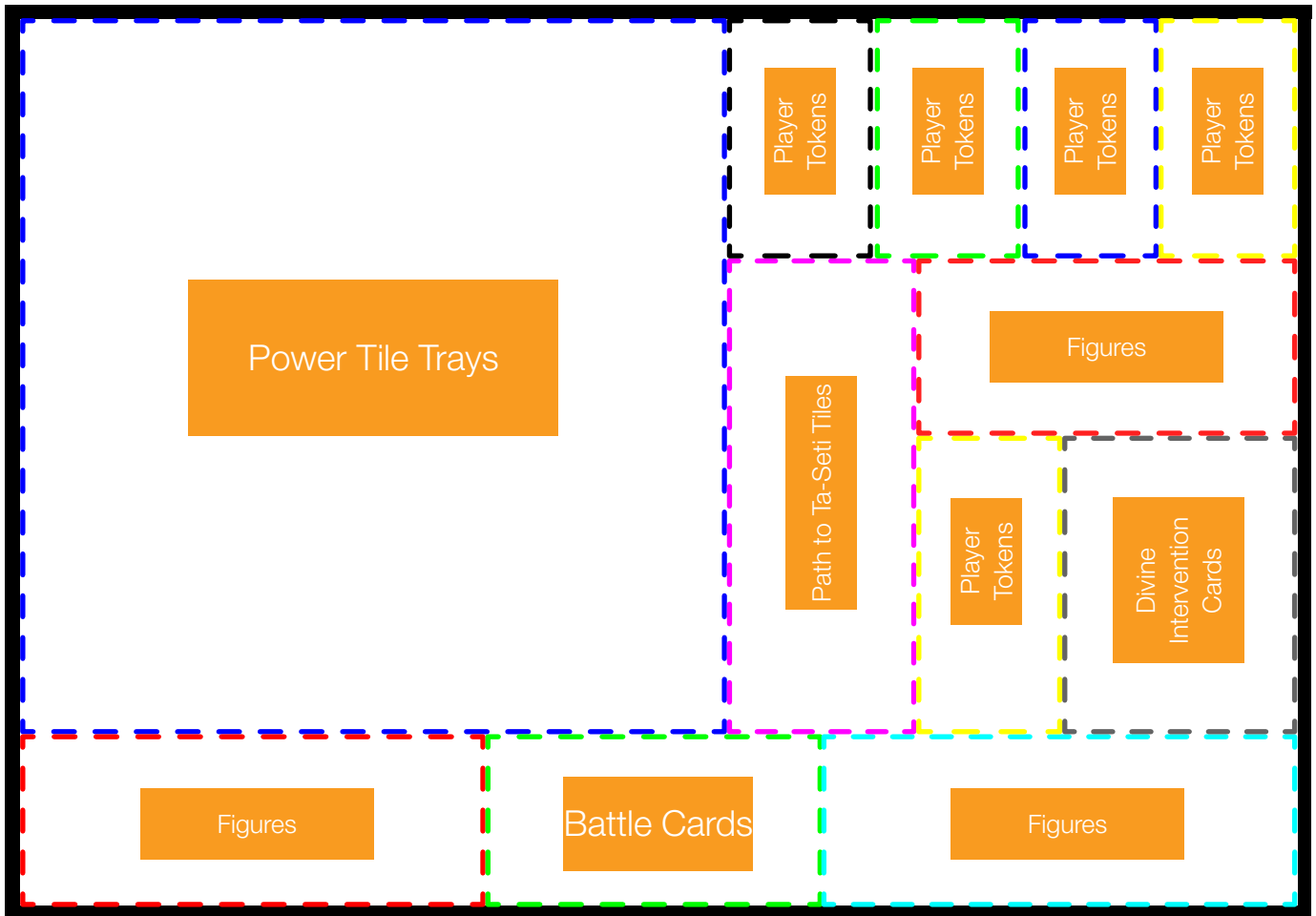

This Quick Start Insert is compatible with Kemetic and its expansions. This is a non-licensed product. ALL RIGHTS RESERVED by their respective trademark holders. No challenge to any intellectual property rights is intended or implied by representations of compatibility and no endorsements of any of our products by any other company is implied or represented.



QUICK START INSERT™ FOR KEMET®

Top Layer

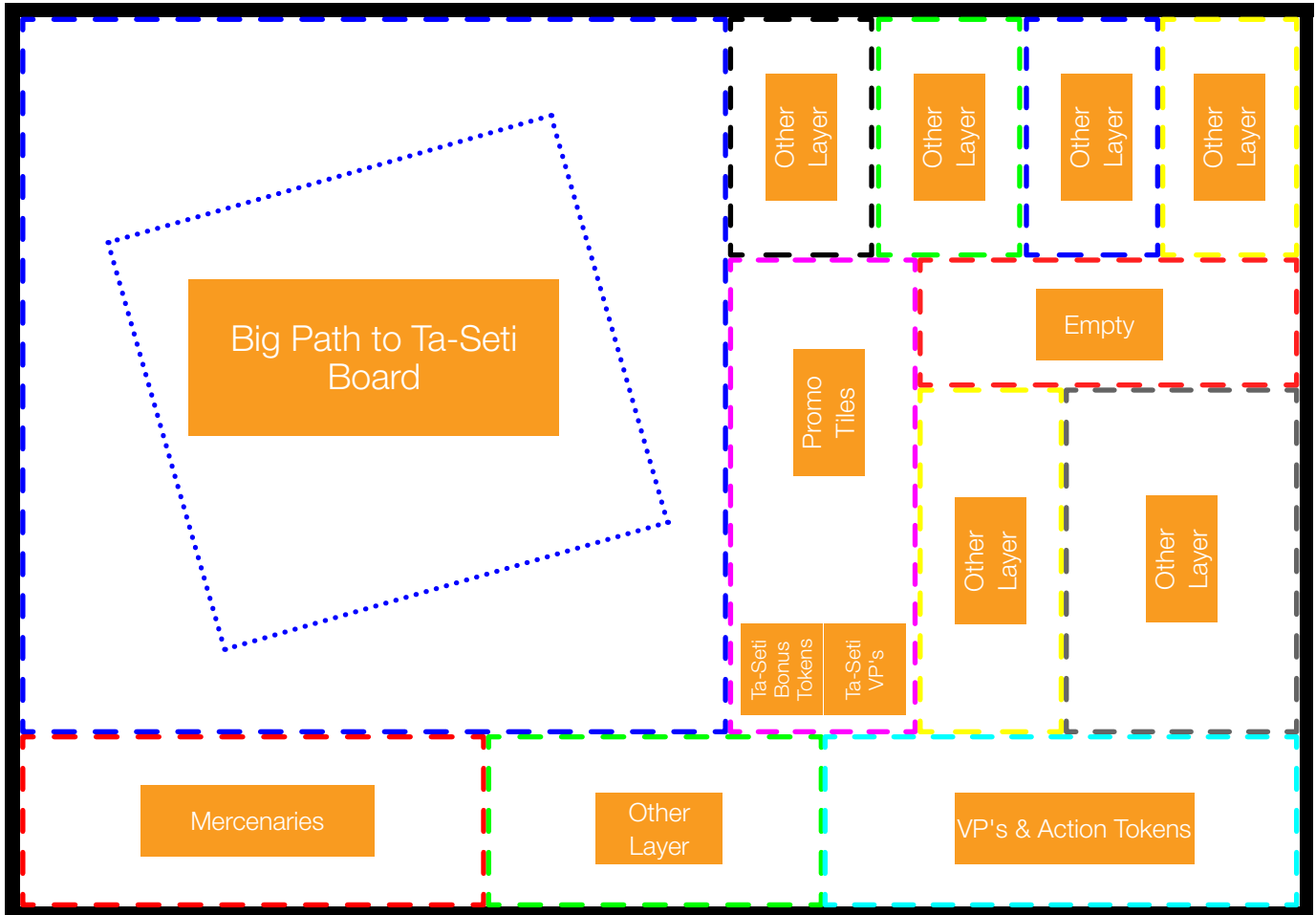

This Quick Start Insert is compatible with Kemet and its expansions. This is a non-licensed product. ALL RIGHTS RESERVED by their respective trademark holders. No challenge to any intellectual property rights is intended or implied by representations of compatibility and no endorsements of any of our products by any other company is implied or represented.